

**DAIKIN**



# OPERATION MANUAL

## Condenserless water-cooled water chillers



EWLP012KAW1N  
EWLP020KAW1N  
EWLP026KAW1N  
EWLP030KAW1N  
EWLP040KAW1N  
EWLP055KAW1N  
EWLP065KAW1N

**CONTENTS**

	Page
Introduction .....	1
Technical specifications .....	1
Electrical specifications .....	2
Description .....	2
Function of the main components.....	3
Safety devices.....	3
Internal wiring - Parts table.....	4
Before operation.....	5
Checks before initial start-up.....	5
Water supply.....	5
Power supply connection and crankcase heating.....	5
General recommendations.....	5
Operation .....	5
Digital controller.....	5
Working with the EWLP units .....	6
Advanced features of the digital controller.....	8
Troubleshooting.....	11
Maintenance.....	12
Important information regarding the refrigerant used.....	12
Maintenance activities .....	12
Disposal requirements.....	12



READ THIS MANUAL ATTENTIVELY BEFORE STARTING UP THE UNIT. DO NOT THROW THIS MANUAL AWAY. KEEP IT IN YOUR FILES FOR FUTURE REFERENCE. Read the chapter "Overview of the user parameters" on page 8 before changing the parameters.

**INTRODUCTION**

This operation manual concerns condenserless water-cooled water chillers of the Daikin EWLP-KA series. These units are provided for indoor installation and used for cooling applications. The EWLP units can be combined with Daikin fan coil units or air handling units for air conditioning purposes. They can also be used for supplying water for process cooling.

This manual has been prepared to ensure adequate operation and maintenance of the unit. It will tell you how to use the unit properly and will provide help if problems occur. The unit is equipped with safety devices, but they will not necessarily prevent all problems caused by improper operation or inadequate maintenance.

In case of persisting problems contact your local Daikin Dealer.



Before starting up the unit for the first time, make sure that it has been properly installed. It is therefore necessary to carefully read the installation manual supplied with the unit and the recommendations listed in "Before starting".

**Technical specifications<sup>(1)</sup>**

General EWLP		012	020	026	030
Dimensions HxWxD	(mm)		600x600x600		
Machine weight	(kg)	104	138	144	149
Connections					
• condenser discharge connection (copper)	(mm)	12.7 flare	19.1 flare	19.1 flare	19.1 flare
• condenser liquid connection (copper)	(mm)	9.52 flare	12.7 flare	12.7 flare	12.7 flare

General EWLP		040	055	065
Dimensions HxWxD	(mm)		600x600x1200	
Machine weight	(kg)	252	265	274
Connections				
• condenser discharge connection (copper)	(mm)	2x 19.1 flare	2x 19.1 flare	2x 19.1 flare
• condenser liquid connection (copper)	(mm)	2x 12.7 flare	2x 12.7 flare	2x 12.7 flare

Compressor EWLP		012	020	026	030
Model		JT140BF-YE	JT212DA-YE	JT300DA-YE	JT335DA-YE
Speed	(rpm)	2900			
Oil type		FVC68D			
Oil charge volume	(l)	1.5	2.7	2.7	2.7
Refrigerant type		R407C			

Evaporator		braced plate heat exchanger			
Min. water volume	(l)	62.1	103	134	155
Water flow range	(l/min)	17~69	29~115	38~153	45~179

**Condenser**  
 refer to engineering specifications as published by the supplier of your remote condenser

Compressor EWLP		040	055	065
Model		2x JT212DA-YE	2x JT300DA-YE	2x JT335DA-YE
Speed	(rpm)	2900		
Oil type		FVC68D		
Oil charge volume	(l)	2x 2.7	2x 2.7	2x 2.7
Refrigerant type		R407C		

Evaporator		braced plate heat exchanger		
Min. water volume	(l)	205	268	311
Water flow range	(l/min)	57~229	77~307	89~359

**Condenser**  
 refer to engineering specifications as published by the supplier of your remote condenser

(1) Refer to the engineering data book for the complete list of specifications.

## Electrical specifications<sup>(1)</sup>

Model EWLP	012	020	026	030
<b>Power supply</b>				
• Phase			3N~	
• Frequency (Hz)			50	
• Voltage (V)			400	
• Voltage tolerance (%)			±10	
• Recommended fuses (aM)	3x 16	3x 20	3x 25	3x 32
<b>Compressor</b>				
• Phase			3~	
• Frequency (Hz)			50	
• Voltage (V)			400	
• Nominal running current (A)	7.4	11.6	14.7	16.8
<b>Control</b>				
• Phase			1~	
• Frequency (Hz)			50	
• Voltage (V)			230	
• Recommended fuses (aM)			factory installed	

Model EWLP	040	055	065
<b>Power supply</b>			
• Phase			3N~
• Frequency (Hz)			50
• Voltage (V)			400
• Voltage tolerance (%)			±10
• Recommended fuses (aM)	3x 40	3x 50	3x 50
<b>Compressor</b>			
• Phase			3~
• Frequency (Hz)			50
• Voltage (V)			400
• Nominal running current (A)	11.6	14.7	16.8
<b>Control</b>			
• Phase			1~
• Frequency (Hz)			50
• Voltage (V)			230
• Recommended fuses (aM)			factory installed

## DESCRIPTION

The EWLP condenserless water-cooled water chillers are available in 7 standard sizes.

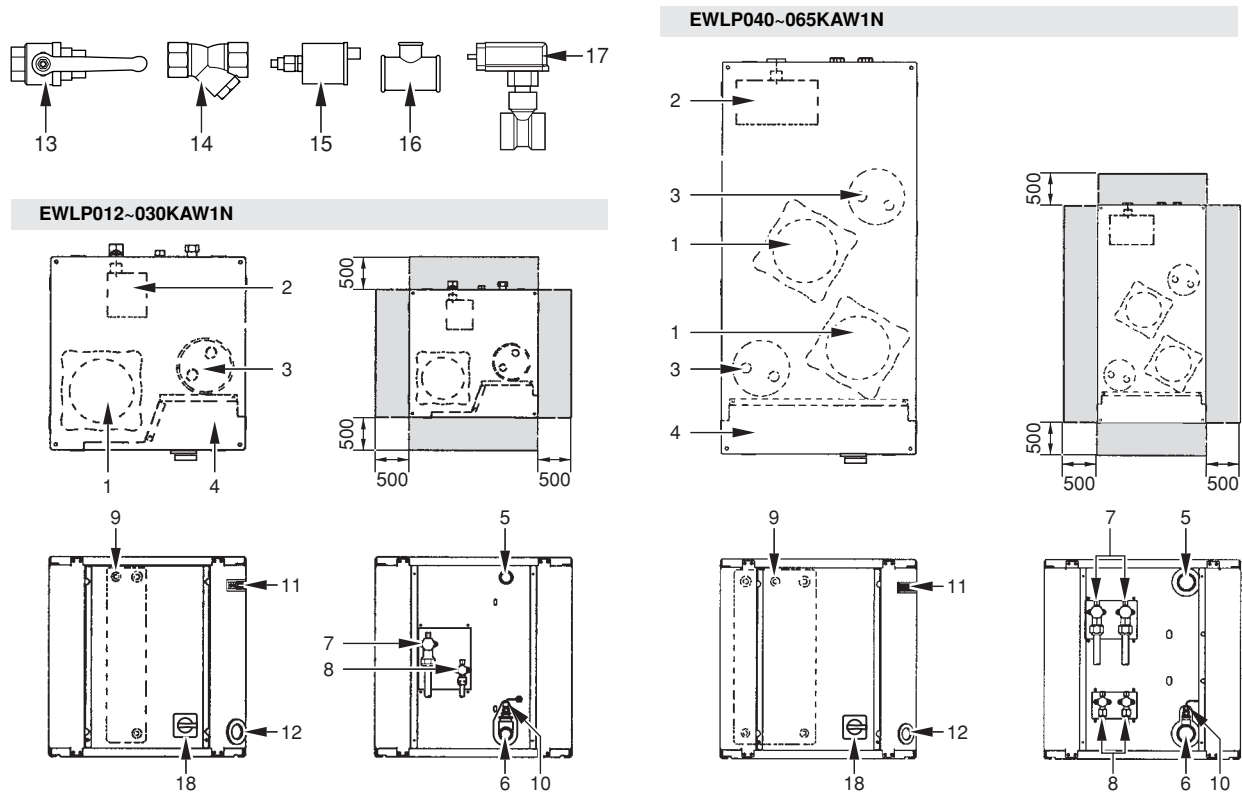

Figure: Main components

- |    |  |    |  |
|----|--|----|--|
| 1  | Compressor                                   | 11 | Digital display controller                   |
| 2  | Evaporator                                   | 12 | Power supply intake                          |
| 3  | Accumulator                                  | 13 | Ball valve (field installed)                 |
| 4  | Switchbox                                    | 14 | Water filter (field installed)               |
| 5  | Chilled water in                             | 15 | Air purge valve (field installed)            |
| 6  | Chilled water out                            | 16 | T-joint for air purge (field installed)      |
| 7  | Discharge stop valve                         | 17 | Flow switch (with T-joint) (field installed) |
| 8  | Liquid stop valve                            | 18 | Main switch                                  |
| 9  | Evaporator entering water temperature sensor |    |  |
| 10 | Freeze up sensor                             |    |  |
- Required space around the unit for service

(1) Refer to the engineering data book for the complete list of specifications.

## Function of the main components

EWLP012~030KAW1N

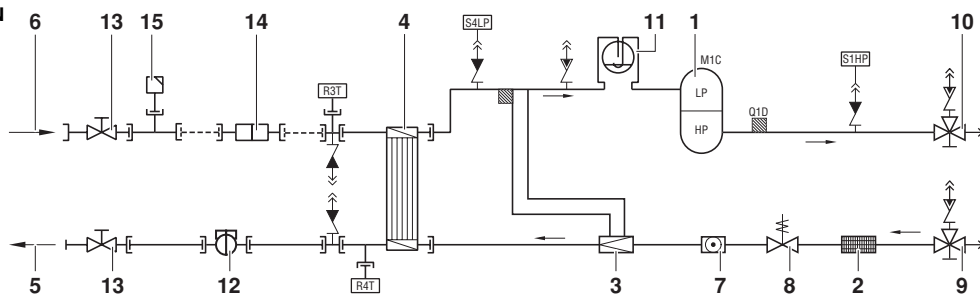

EWLP040~065KAW1N

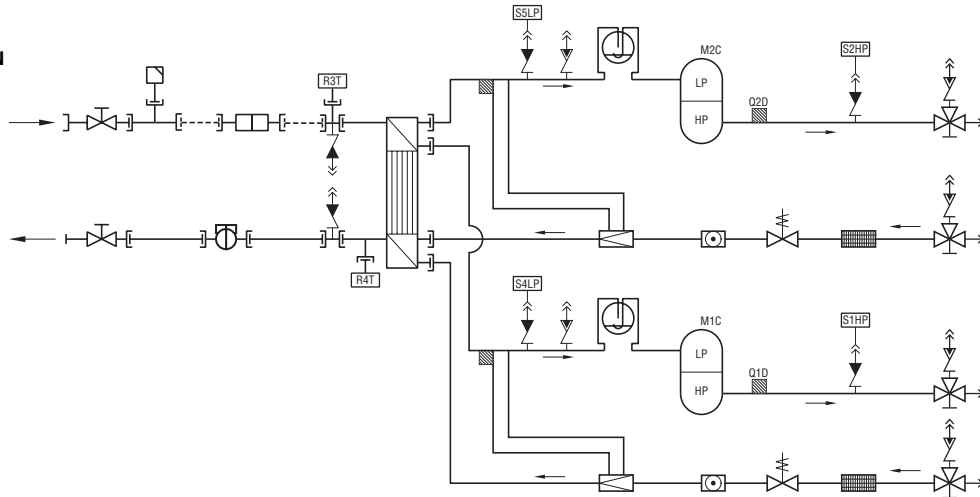

Figure: Functional diagram

- |   |                         |         |   |
|---|-------------------------|---------|---|
| 1 | Compressor              | 9       | Liquid stop valve   |
| 2 | Filter                  | 10      | Discharge stop valve  |
| 3 | Expansion valve         | 11      | Accumulator   |
| 4 | Evaporator              | 12      | Flow switch (delivered with the unit, installed in the field)     |
| 5 | Evaporator water outlet | 13      | Ball valve (delivered with the unit, installed in the field)      |
| 6 | Evaporator water inlet  | 14      | Water filter (delivered with the unit, installed in the field)    |
| 7 | Sight glass             | 15      | Air purge valve (delivered with the unit, installed in the field) |
| 8 | Liquid solenoid valve   | - - - - | Field piping  |

As the refrigerant circulates through the unit, changes in its state or condition occur. These changes are caused by the following main components:

- **Compressor**  
The compressor (M<sup>\*</sup>C) acts as a pump and circulates the refrigerant in the refrigeration circuit. It compresses the refrigerant vapour coming from the evaporator to a pressure at which it can easily be liquified in the condenser.
- **Filter**  
The filter installed behind the condenser removes small particles from the refrigerant to prevent blockage of the tubes.
- **Expansion valve**  
The liquid refrigerant coming from the condenser enters the evaporator via an expansion valve. The expansion valve brings the liquid refrigerant to a pressure at which it can easily be evaporated in the evaporator.
- **Evaporator**  
The main function of the evaporator is to take heat from the water that flows through it. This is done by turning the liquid refrigerant, coming from the condenser, into gaseous refrigerant.
- **Water in/outlet connections**  
The water inlet and outlet connection allow an easy connection of the unit to the water circuit of the air handling unit or industrial equipment.

## Safety devices

The unit is equipped with *General safety devices*: shut down all circuits and stop the whole unit.

- **I/O PCB (A2P) (input/output)**  
The I/O PCB (A2P) contains a reverse phase protector.  
The reverse phase protector detects if the 3 phases of the power supply are connected correctly. If a phase is not connected or if 2 phases are inverted, the unit can not start up.
- **Overcurrent relay**  
The overcurrent relay (K<sup>\*</sup>S) is located in the switch box of the unit and protects the compressor motor in case of overload, phase failure or too low voltage. The relay is factory-set and may not be adjusted. When activated, the overcurrent relay has to be reset in the switch box and the controller needs to be reset manually.
- **High-pressure switch**  
The high-pressure switch (S<sup>\*</sup>HP) is installed on the discharge pipe of the unit and measures the condenser pressure (pressure at the outlet of the compressor). When the pressure is too high, the pressure switch is activated and the circuit stops.  
When activated, it resets automatically, but the controller needs to be reset manually.

■ Low pressure switch

The low-pressure switch (S\*LP) is installed on the suction pipe of the unit and measures the evaporator pressure (pressure at the inlet of the compressor). When the pressure is too low, the pressure switch is activated and the circuit stops.

When activated, it resets automatically, but the controller needs to be reset manually.

■ Discharge thermal protector

The discharge thermal protector (Q\*D) is activated when the temperature of the refrigerant leaving the compressor becomes too high. When the temperature returns to normal, the protector resets automatically, but the controller needs to be reset manually.

■ Freeze up sensor

The outlet water temperature sensor (R4T) measures the temperature of the water at the water heat exchanger outlet. The protection device shuts down the circuit when the temperature of the chilled water becomes too low in order to prevent freezing of the water during operation.

When the outlet water temperature returns to normal, the protector resets automatically, but the controller needs to be reset manually.

■ Fuse for control circuit (F1U)

The fuse for control circuit protects cables of control circuit and controller components in case of short circuit.

■ Fuse for control circuit (F4)

The fuse for control circuit protects cables of control circuit in case of short circuit.

■ Fuse for digital controller (F3U)

The fuse protects cables of digital controller and digital controller in case of short circuit.

■ Flow switch (delivered with the unit, installed in the field)

The flow switch measures the flow in the water circuit. In case the flow does not reach the minimum allowed water flow, the unit will be shut down.

■ Ball valve (delivered with the unit, installed in the field)

A ball valve is installed in front of and behind the water filter to allow filter cleaning without having to drain the water circuit.

■ Water filter (delivered with the unit, installed in the field)

The filter installed in front of the unit removes dirt from the water to prevent damage to the unit or blockage of the evaporator or condenser. The water filter should be cleaned on a regular base.

■ Air purge valve (delivered with the unit, installed in the field)

Remaining air in the chiller water system will be automatically removed via the air purge valve.

## Internal wiring - Parts table

Refer to the internal wiring diagram supplied with the unit. The abbreviations used are listed below:

A1P .....	PCB: controller PCB
A2P .....	PCB: I/O PCB (input/output)
A3P .....	** .... PCB: Address card for BMS <sup>(1)</sup>
A5P,A6P .....	** .... PCB: Softstarter for circuit 1, circuit 2 <sup>(1)</sup>
A7P .....	** .... PCB: Remote user interface <sup>(1)</sup>
E1H,E2H .....	Crankcase heater circuit 1, circuit 2
F1,F2,F3 .....	#..... Main fuses for the unit <sup>(2)</sup>
F4 .....	* ..... Fuse I/O PCB
F5 .....	##... Surge proof fuse (optional for BMS)
F6 .....	#..... Fuse for pumpcontactor <sup>(2)</sup>
F1U .....	Fuse I/O PCB
F3U .....	Fuse for controller PCB
H3P .....	* ..... Indication lamp alarm <sup>(2)</sup>
H4P .....	* ..... Indication lamp operation compressor 1 <sup>(2)</sup>
H5P .....	* ..... Indication lamp operation compressor 2 <sup>(2)</sup>
H6P .....	* ..... Indication lamp general operation <sup>(2)</sup>
K1F,K2F .....	#..... Auxiliary contactor for fan motors
K1M,K2M .....	Compressor contactor circuit 1, circuit 2
K4S,K5S .....	Overcurrent relay circuit 1, circuit 2
K6S .....	* ..... Overcurrent relay pump <sup>(2)</sup>
K1P .....	* ..... Pumpcontactor
M1C,M2C .....	Compressor motor circuit 1, circuit 2
PE .....	Main earth terminal
Q1D,Q2D .....	Discharge thermal protector circuit 1, circuit 2
R3T .....	Evaporator inlet water temperature sensor
R4T .....	Evaporator outlet water temperature sensor
R5T .....	Condenser inlet temperature sensor
S1HP,S2HP .....	High pressure switch circuit 1, circuit 2
S4LP,S5LP .....	Low pressure switch circuit 1, circuit 2
S7S .....	* ..... Switch for remote cooling/heating selection <sup>(2)</sup>
S9S .....	* ..... Switch for remote start/stop <sup>(2)</sup>
S10L .....	Flow switch
S12M .....	Main isolator switch
TR1 .....	Transfo 230 V → 24 V for supply of controller PCB
TR2 .....	Transfo 230 V → 24 V for supply of I/O PCB (A2P)
Y3R .....	Reversingvalve
Y1S, Y2S .....	Liquid solenoid valve
X1~3,X1~82A .....	Connectors

	Not included with standard unit	
	Not possible as option	Possible as option
Obligatory	#	##
Not obligatory	*	**

(1) optional  
(2) field supply

## BEFORE OPERATION

### Checks before initial start-up

-  Make sure that the circuit breaker on the power supply panel of the unit is switched off.

After the installation of the unit, check the following before switching on the circuit breaker:

- 1 Field wiring**  
Make sure that the field wiring between the local supply panel and the unit has been carried out according to the instructions described in the installation manual, according to the wiring diagrams and according to European and national regulations.
- 2 Fuses or protection devices**  
Check that the fuses or the locally installed protection devices are of the size and type specified in the installation manual. Make sure that neither a fuse nor a protection device has been bypassed.
- 3 Earth wiring**  
Make sure that the earth wires have been connected properly and that the earth terminals are tightened.
- 4 Internal wiring**  
Visually check the switch box on loose connections or damaged electrical components.
- 5 Fixation**  
Check that the unit is properly fixed, to avoid abnormal noises and vibrations when starting up the unit.
- 6 Damaged equipment**  
Check the inside of the unit on damaged components or squeezed pipes.
- 7 Refrigerant leak**  
Check the inside of the unit on refrigerant leakage. If there is a refrigerant leak, call your local dealer.
- 8 Oil leak**  
Check the compressor on oil leakage. If there is an oil leak, call your local dealer.
- 9 Power supply voltage**  
Check the power supply voltage on the local supply panel. The voltage should correspond to the voltage on the identification label of the unit.

### Water supply

Fill the water piping, taking into account the minimum water volume required by the unit. Refer to the chapter "Water charge, flow and quality" in the installation manual.

Make sure that the water is of the quality as mentioned in the installation manual.

Purge the air at the high points of the system and check the operation of the circulation pump and the flow switch.

- 
- Use a good thread sealant for the sealing of the connections. The sealing must be able to withstand the pressures and temperatures of the system, it must also be resistant to the used glycol in the water.
  - The exterior of the water pipes must be adequately protected against corrosion.

### Power supply connection and crankcase heating

-  In order to avoid compressor damage, it is necessary to switch on the crankcase heater for **at least six hours** before starting the compressor after a long period of standstill.

To switch on the crankcase heater proceed as follows:

- 1** Switch on the circuit breaker on the unit. Make sure that the unit is "OFF" on the controller.
- 2** The crankcase heater is switched on automatically.
- 3** Check the supply voltage on the supply terminals L1, L2, L3, (N) by means of a voltmeter. The voltage should correspond to the voltage indicated on the identification label of the unit. If the voltmeter reads values which are not within the ranges specified in the technical data, check the field wiring and replace the supply cables if necessary.
- 4** Check the LED on the reverse phase protector. If it lights up, the phase order is correct. If not, switch off the circuit breaker and call a licensed electrician to connect the wires of the power supply cable in the correct phase order.

After six hours, the unit is ready for operation.

### General recommendations

Before switching on the unit, read following recommendations:

- 1** When the complete installation and all necessary settings have been carried out, close all front panels of the unit.
- 2** The service panel of the switch box may only be opened by a licensed electrician for maintenance purposes.

## OPERATION

The EWLP units are equipped with a digital controller offering a user-friendly way to set up, use and maintain the unit.

This part of the manual has a task-oriented, modular structure. Apart from the first section, which gives a brief description of the controller itself, each section or subsection deals with a specific task you can perform with the unit.

### Digital controller

#### User interface

The digital controller consists of a numeric display, four labelled keys which you can press and four LEDs providing extra user information.

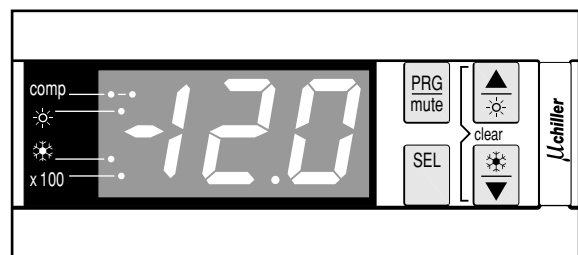



















Figure: Digital controller

### Keys provided on the controller:

Each key, except for the lower left key, combines two functions: /  
, / and /. The function carried out when the user presses one of these keys depends on the status of the controller and the unit at that specific moment.

	key, to enter the scroll list of user parameters, to confirm a parameter modification and to return to normal operation.
	key, to de-activate the buzzer in the case of an alarm.
	key, to scroll through the list of direct or user parameters or to raise a setting.
	key, has no effect on EWLP units.
	key, to enter the scroll list of direct parameters or to switch between a parameter's code and its value.
	key, to start the unit in cooling mode or to switch the unit off when cooling mode is active.
	key, to scroll through the list of direct or user parameters or to lower a setting.

### LEDs provided on the controller:

	LEDs, indicates the status of the compressor 1 (left LED) and compressor 2 (right LED). The  LEDs do not light up when the compressor is not active, blinks when the compressor cannot start up although extra load is requested (e.g. timer active) and lights up permanently when the compressor is active.
	LED, is not used.
	LED, indicates that cooling mode is active.
	LED, indicates that the value on the numeric display should be multiplied by 100.

**NOTE** Temperature readout tolerance:  $\pm 1^{\circ}\text{C}$ .



Legibility of the numeric display may decrease in direct sunlight.

### Direct and user parameters

The digital controller provides direct and user parameters. The direct parameters are important for the everyday usage of the unit, e.g. to adjust the temperature setpoint or to consult actual operational information. The user parameters on the contrary provide advanced features such as adjusting time delays or disabling the buzzer.

Each parameter is defined by a code and a value. For example, the parameter used to select local or remote on/off control has code  $H7$  and value  $I$  or  $\emptyset$ .

### Working with the EWLP units

This chapter deals with the everyday usage of the EWLP units. Here, you will learn how to perform routine tasks, such as:



- switching the unit on and off,
- adjusting the temperature setpoint,
- consulting actual operational information,
- resetting alarms,
- resetting warnings.

#### Switching the EWLP unit on

To switch the EWLP unit on, proceed as follows:

- 1 When the on/off digital input user parameter  $H7$  is set to  $\emptyset$  (=No), press the  key for approximately 5 seconds to switch the unit on in cooling mode (inlet water temperature control of evaporator).

When the on/off digital input user parameter  $H7$  is set to  $I$  (=Yes), you can also switch the unit on using the remote on/off switch (installed by the customer).

In both cases an initialization cycle is started and the  LED starts blinking. The  LED, lights up when the unit is switched on. Once all the timers have reached zero, the unit starts up and the  LED lights up permanently. The numeric display shows the actual inlet water temperature of the evaporator.

- 2 When the unit is started up for the first time, or when the unit has been out of operation for a longer period, it is recommended to go through the following checklist.

#### Abnormal noise and vibrations

Make sure the unit does not produce any abnormal noises or vibrations: check the fixations and piping. If the compressor makes any abnormal noises, this may also be caused by an overcharge of refrigerant.

#### Working pressure

It is important to check the high and low pressure of the refrigerant circuit to ensure the proper operation of the unit and to guarantee that the rated output will be obtained.

For reference, the average saturated temperature of R407C in relation to the pressure readout can be found in "Annex I" on page 13.



The pressures measured will vary between a maximum and minimum value, depending on the water and outdoor temperatures (at the moment of measurement).

- 3 If the unit does not start after a few minutes, consult the actual operational information available in the list of direct parameters. Also refer to the chapter "Troubleshooting" on page 11.

**NOTE**



In case of remote on/off control ( $H7=I$ ), it is recommended to install an on/off switch near the unit in series with the remote switch. The unit can then be switched off from either place.

#### Switching the EWLP unit off

To switch the EWLP unit off, proceed as follows:

- 1 When the on/off digital input user parameter  $H7$  is set to  $\emptyset$  (=No) and the unit is on, press the  key for approximately 5 seconds to switch the unit off.

The  LED and the  LED are extinguished.

- 2 When the on/off digital input user parameter  $H7$  is set to  $I$  (=Yes), switch the unit off using the remote on/off switch.

The  LED and the  LED are extinguished.

---

## Adjusting the cooling temperature setpoint

---

The EWLP units enable definition and modification of the cooling temperature setpoint. The default, limit and step values for the cooling setpoint are:

- Default value 12.0°C
- Limit values 7.0 to 25.0°C
- Step value 0.1°C

To adjust the cooling temperature setpoint, proceed as follows:

- 1 Press the **[SEL]** key for approximately 5 seconds to enter the list of direct parameters.  
The direct parameter code *r1* defining the cooling temperature setpoint appears on the display.
- 2 Press the **[SEL]** key.  
The actual cooling temperature setpoint appears on the display.
- 3 Press the **[▲]** or **[▼]** key to raise, respectively lower the temperature setting.
- 4 Press the **[SEL]** key to return to parameter code *r1*.
- 5 To save the adjusted temperature setpoint, press the **[PRG]** key. To cancel the modification wait approximately 40 seconds.

In the first case, the controller saves the changes, leaves the list of direct parameters and returns to its normal operation, displaying the inlet water temperature.

In the second case the display starts flashing. Approximately 40 seconds later, the controller leaves the list of direct parameters without saving the modified parameter. The inlet water temperature reappears on the display.

---

**NOTE**  By pressing any button while the display is flashing and cancelling of all changes is in progress, the cancelling process is stopped, the display stops flashing and the user can continue to change the settings.

---

---

## Consulting actual operational information

---

The actual operational information that can be consulted in the list of direct parameters consists of:

- *r5* : outlet water temperature evaporator,
- *r8* : ambient temperature,
- *c9* : total running hours of the compressor1,
- *cR* : total running hours of the compressor2,
- *cL* : total running hours of the pump.

To consult the actual operational information, proceed as follows:

- 1 Press the **[SEL]** key for approximately 5 seconds to enter the list of direct parameters.  
The direct parameter code *r1* defining the cooling temperature setpoint appears on the display.
- 2 Depending on the information to be consulted, select parameter code *r5*, *r8*, *c9*, *cR* or *cL* using the **[▲]** and/or **[▼]** key.
- 3 Press the **[SEL]** key to consult the actual value of the selected parameter.
- 4 Press the **[SEL]** key to return to the parameter codes.
- 5 To consult other actual operational information, repeat from instruction 2 onwards.
- 6 To return to normal operation, press the **[PRG]** key or wait approximately 40 seconds.

In the first case, the controller immediately leaves the list of direct parameters and returns to normal operation displaying the inlet water temperature.

In the second case, the display will start flashing. Approximately 40 seconds later, the controller leaves the list of direct parameters. The inlet water temperature reappears on the display.

---

**NOTE**  To reset the timers *c9*, *cR* and *cL*, refer to chapter "Resetting warnings" on page 8.

---

---

## Resetting alarms

---

When an alarm is detected, the following happens:

- the buzzer is activated (if enabled by means of user parameter *P4*),
- the alarm relay is energized,
- the display starts flashing, alternately showing the alarm code and the inlet water temperature.

The following alarm codes may appear on the screen:

- *R1*: indicates an anti-freeze alarm,
- *E1*: indicates that the NTC probe used to measure the evaporator inlet water temperature is defective,
- *E2*: indicates that the NTC probe used to measure the outlet water temperature is defective,
- *E3*: indicates that the NTC probe used to measure the ambient temperature is defective,
- *EE,EP*: indicates that the EEPROM on the controller PCB inside the unit is defective,
- *EU,EG*: indicates that the supply voltage is exceedingly low (*EU*) or exceedingly high (*EG*). In these cases contact a licensed electrician,
- *EL*: indicates that the power supply has a "remarkable noise". In this case contact a licensed electrician,
- *FL*: indicates that there was no water flow either during the period of 15 seconds after the pump was started or for 5 seconds while the compressor is active,
- *H1*: indicates that a high pressure switch, the discharge thermal protection or the overcurrent protection of the compressor motor is activated,
- *L1*: indicates that the low pressure switch is activated.

---

**NOTE**  If the alarm codes *FL* and *H1* are flashing alternately, the alarm is most probably caused by the reverse phase protector or by the fuse for control circuit (*F4*) that is blown.

---

To reset an alarm, proceed as follows:

- 1 Press the **[mute]** key to acknowledge the alarm.  
The buzzer is de-activated.
- 2 Find the cause of shutdown and correct.  
Refer to the chapter "Troubleshooting" on page 11.
- 3 If the alarm codes *R1*, *FL*, *H1* or *L1* appear on the display, reset the alarm manually by pressing the **[▲]** and **[▼]** key simultaneously for approximately 5 seconds.

In all other cases the alarm is reset automatically.

Once the alarm is reset, the error code no longer appears on the display. The controller continues its normal operation, displaying the inlet water temperature.



## Resetting warnings

During normal operation, the display of the controller may start flashing, alternately showing the inlet water temperature and the following warning code:

- $n1$ : indicates that the compressor1 requires maintenance: the total running hours of the compressor1 (direct parameter  $c9$ ) has exceeded the setting of the timer threshold for maintenance warning (user parameter  $cb$ ).
- $n2$ : indicates that the compressor2 requires maintenance: the total running hours of the compressor2 (direct parameter  $cA$ ) has exceeded the setting of the timer threshold for maintenance warning (user parameter  $cb$ ).

To reset the maintenance warning  $n1$  or  $n2$ , proceed as follows:

- 1 Enter the list of direct parameters by pressing the **[SEL]** key for approximately 5 seconds.  
The parameter code  $r1$  appears on the display.
- 2 Select parameter code  $c9$  or  $cA$  using the **[▲]** and/or **[▼]** key.
- 3 Press the **[SEL]** key to switch to the parameter value.
- 4 Press the **[▲]** and **[▼]** keys simultaneously for approximately 5 seconds.  
The timer's value becomes  $0$ .
- 5 Press the **[SEL]** key to return to parameter code  $c9$  or  $cA$ .
- 6 Press the **[PRG]** key to return to normal operation.

### NOTE



Do not forget to carry out the required maintenance activities after resetting the timers.

Besides resetting timer  $c9$  (running hours of the compressor 1) and  $cA$  (running hours of the compressor 2), it is also possible to reset timer  $cL$  which defines the total running hours of the pump. To do this, consult the timer's value (refer to paragraph "Consulting actual operational information" on page 7) and press the **[▲]** and **[▼]** keys simultaneously for approximately 5 seconds while the timer's value is displayed. The timer's value becomes  $0$ . Then successively press the **[SEL]** key and the **[PRG]** key to return to normal operation.

## Advanced features of the digital controller

This chapter gives an overview of the direct parameters and user parameters provided by the controller. In the following chapter, you will learn how you can set up and configure the EWLP unit using these parameters.

### Overview of the direct parameters

The list of direct parameters is accessible by pressing the **[SEL]** key for approximately 5 seconds.

When scrolling through the list of direct parameters using the **[▲]** and/or **[▼]** key, the parameters appear in the following order:

- $r1$ : to define the cooling temperature setpoint,
- $r2$ : to define the cooling temperature difference,
- $r5$ : to check the evaporator outlet water temperature,
- $r8$ : to check the ambient temperature
- $c9$ : to check the total running hours of the compressor1,
- $cA$ : to check the total running hours of the compressor2,
- $cL$ : to check the total running hours of the pump.

### Overview of the user parameters

The list of user parameters is only accessible by means of the user password. When scrolling through the list of parameters using the **[▲]** and/or **[▼]** key, you see the direct parameters and user parameters. The user parameters appear in the following order:

- $rD$ : to define the measurement unit ( $^{\circ}\text{C}$  or  $^{\circ}\text{F}$ ),
- $c7$ : to define the time delay between the pump startup and the compressor startup,
- $c8$ : to define the time delay between the unit shutdown and the pump shutdown,
- $cb$ : to define the time threshold for maintenance warning,
- $P4$ : to disable the buzzer or to define the activation period of the buzzer in case of an alarm,
- $H7$ : to activate or de-activate the remote on/off control,
- $H9$ : to lock or unlock the controller keyboard,
- $HA$ : to define the unit's serial address,
- $HB, Hb, c5$ : not used.

### Tasks carried out using direct parameters

#### Entering the list of direct parameters

- 1 Press the **[SEL]** key for approximately 5 seconds.  
The controller enters the list of direct parameters, displaying parameter code  $r1$ .

#### Defining the cooling temperature difference

To control the cooling load, the unit with 1 compressor is equipped with a single-step thermostat. The unit with 2 compressors is equipped with a two-step thermostat. The thermostat's "cooling temperature difference" can be modified by means of direct parameter  $r2$ .

The default, limit and step values are:

- Default value  $3.0^{\circ}\text{C}$

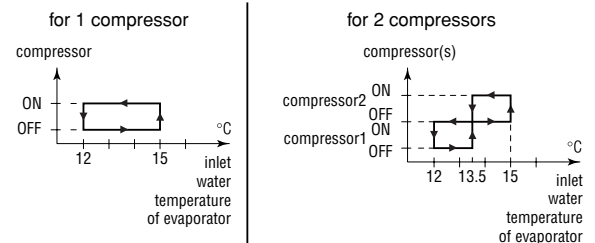

- Limit values  $0.3$  to  $19.9^{\circ}\text{C}$
- Step value  $0.1^{\circ}\text{C}$

To define the cooling temperature difference, proceed as follows:

- 1 Enter the list of direct parameters.
- 2 Press the **[▲]** key once.  
Direct parameter code  $r2$  appears on the display.
- 3 Press the **[SEL]** key to switch to the parameter value.
- 4 Select the appropriate setting using the **[▲]** and/or **[▼]** key.
- 5 Press the **[SEL]** key to switch to the list of parameter codes.
- 6 To adjust or to consult other direct parameters before saving the modifications, select another direct parameter using the **[▲]** and/or **[▼]** key and then repeat from instruction 3 onwards.

- 7 To save the modifications, press the **PRG** key. To cancel the modifications, wait approximately 40 seconds.

In the first case, the controller saves the changes, leaves the list of direct parameters and returns to normal operation, displaying the inlet water temperature.

In the second case, the display starts flashing. Approximately 40 seconds later, the controller leaves the list of direct parameters without saving the modifications. The inlet water temperature reappears on the display.

### Tasks carried out using user parameters

#### Entering the list of user parameters

Access to the list of user parameters is protected by the user password (a 3-digit number between 0 and 99).

To enter the list of user parameters, proceed as follows:

- 1 Press the **PRG** key for approximately 5 seconds.  
The number 00 starts flashing on the display.
- 2 Enter the correct password using the **▲** and/or **▼** key.  
The password's value is 22.
- 3 Press the **SEL** key to confirm the password and to enter the list of user parameters.  
The controller displays parameter code r<sub>d</sub> (which is the first user parameter).

#### Defining the measurement unit

Depending on the setting of user parameter r<sub>d</sub>, all temperature values are displayed in °C or in °F. The conversion formulas from °C to °F and vice versa are:

- $T_{°C} = (T_{°F} - 32)/1.8$
- $T_{°F} = (T_{°C} \times 1.8) + 32$

If user parameter r<sub>d</sub> is set to 0, all temperatures appearing on the display will be expressed in °C. If user parameter r<sub>d</sub> is set to 1 all temperatures will be expressed in °F.

To define the measurement unit, proceed as follows:

- 1 Enter the list of user parameters.  
Parameter code r<sub>d</sub> appears on the display.
- 2 Press the **SEL** key to switch to the parameter value.
- 3 Select the appropriate setting using the **▲** and/or **▼** key.
- 4 Press the **SEL** key to return to the list of parameter codes.
- 5 To adjust or to consult other user parameters before saving the modifications, select another user parameter using the **▲** and/or **▼** key and then repeat from instruction 2 onwards.
- 6 To save the modifications, press the **PRG** key. To cancel the modifications wait approximately 40 seconds.  
In the first case, the controller saves the changes, leaves the list of user parameters and returns to normal operation, displaying the inlet water temperature.  
In the second case, the display starts flashing. Approximately 40 seconds later, the controller leaves the list of user parameters without saving the modifications. The inlet water temperature reappears on the display.

#### Defining the time delay between pump and compressor startup

User parameter c<sub>7</sub> allows you to define the time delay between the pump startup and the compressor startup. The default, limit and step values for the time delay are:

- Default value 15 sec
- Limit values 0 to 150 sec
- Step value 1 sec

To define the time delay, proceed as follows:

- 1 Enter the list of user parameters.  
Parameter code r<sub>d</sub> appears on the display.
- 2 Select parameter code c<sub>7</sub> using the **▲** and/or **▼** key.  
Parameter code c<sub>7</sub> appears on the display.
- 3 Press the **SEL** key to switch to the parameter value.
- 4 Select the appropriate setting using the **▲** and/or **▼** key.
- 5 Press the **SEL** key to return to the list of parameter codes.
- 6 To adjust or to consult other user parameters before saving the modifications, select another user parameter using the **▲** and/or **▼** key and then repeat from instruction 3 onwards.
- 7 To save the modifications, press the **PRG** key. To cancel the modifications wait approximately 40 seconds.

In the first case, the controller saves the changes, leaves the list of user parameters and returns to normal operation, displaying the inlet water temperature.

In the second case, the display starts flashing. Approximately 40 seconds later, the controller leaves the list of user parameters without saving the modifications. The inlet water temperature reappears on the display.

#### Defining the time delay between unit and pump shutdown

User parameter c<sub>8</sub> allows you to define the time delay between the unit shutdown and the pump shutdown, more specifically the period during which the pump will still be active after the unit has been shut down. The default, limit and step values for the time delay are:

- Default value 0 min
- Limit values 0 to 150 min
- Step value 1 min

To define the time delay, proceed as follows:

- 1 Enter the list of user parameters.  
Parameter code r<sub>d</sub> appears on the display.
- 2 Select parameter code c<sub>8</sub> using the **▲** and/or **▼** key.
- 3 Press the **SEL** key to switch to the parameter value.
- 4 Select the appropriate setting using the **▲** and/or **▼** key.
- 5 Press the **SEL** key to return to the list of parameter codes.
- 6 To adjust or to consult other user parameters before saving the modifications, select another user parameter using the **▲** and/or **▼** key and then repeat from instruction 3 onwards.
- 7 To save the modifications, press the **PRG** key. To cancel the modifications wait approximately 40 seconds.

In the first case, the controller saves the changes, leaves the list of user parameters and returns to normal operation, displaying the inlet water temperature.

In the second case, the display starts flashing. Approximately 40 seconds later, the controller leaves the list of user parameters without saving the modifications. The inlet water temperature reappears on the display.

## Defining the timer threshold for maintenance warning

User parameter *cb* allows you to define a timer threshold (running hours of the compressor) after which the controller will generate a maintenance warning or request. The default, limit and step values for the timer threshold are:

- Default value    0 hours
- Limit values    0 to 10,000 hours
- Step value        100 hours

To define the timer threshold, proceed as follows:

- 1 Enter the list of user parameters.  
Parameter code *rd* appears on the display.
- 2 Select parameter code *cb* using the and/or key.
- 3 Press the key to switch to the parameter value.
- 4 Select the appropriate setting using the and/or key.
- 5 Press the key to return to the list of parameter codes.
- 6 To adjust or to consult other user parameters before saving the modifications, select another user parameter using the and/or key and then repeat from instruction 3 onwards.
- 7 To save the modifications, press the key. To cancel the modifications wait approximately 40 seconds.

In the first case, the controller saves the changes, leaves the list of user parameters and returns to normal operation, displaying the inlet water temperature.

In the second case, the display starts flashing. Approximately 40 seconds later, the controller leaves the list of user parameters without saving the modifications. The inlet water temperature reappears on the display.

### NOTE



If the unit is always working in normal conditions, no specific maintenance is requested. In this case the warning function can be disabled by setting parameter *cb* to 0.

## Enabling or disabling the buzzer

When an alarm is detected, the buzzer is activated for the period defined by user parameter *P4*. The default, limit and step values for the activation period are:

- Default value    1 min
- Limit values    0 to 15 min  
                          0 buzzer disabled  
                          15 buzzer active until muted by the user
- Step value        1 min

To enable the buzzer for a certain period or to disable the buzzer, proceed as follows:

- 1 Enter the list of user parameters.  
Parameter code *rd* appears on the display.
- 2 Select parameter code *P4* using the and/or key.
- 3 Press the key to switch to the parameter value.
- 4 Select the appropriate setting using the and/or key.
- 5 Press the key to return to the list of parameter codes.
- 6 To adjust or to consult other user parameters before saving the modifications, select another user parameter using the and/or key and then repeat from instruction 3 onwards.

- 7 To save the modifications, press the key. To cancel the modifications wait approximately 40 seconds.

In the first case, the controller saves the changes, leaves the list of user parameters and returns to normal operation, displaying the inlet water temperature.

In the second case, the display starts flashing. Approximately 40 seconds later, the controller leaves the list of user parameters without saving the modifications. The inlet water temperature reappears on the display.

## Selecting local or remote on/off control

User parameter *H7* in combination with the remote on/off switch (installed by the customer) allows the user to switch the unit on without using the key on the controller.

- When user parameter *H7* is set to 0 (=No), the unit can only be switched on by means of the key on the controller.
- When user parameter *H7* is set to 1 (=Yes), the unit can be switched on by means of the remote on/off switch and the key on the controller.

Key on the controller	Remote On/off switch	UNIT RESULT
ON	ON	ON
ON	OFF	OFF
OFF	ON	OFF
OFF	OFF	OFF

To select local or remote on/off control, proceed as follows:

- 1 Enter the list of user parameters.  
Parameter code *rd* appears on the display.
- 2 Select parameter code *H7* using the and/or key.
- 3 Press the key to switch to the parameter value.
- 4 Select the appropriate setting using the and/or key.
- 5 Press the key to return to the list of parameter codes.
- 6 To adjust or to consult other user parameters before saving the modifications, select another user parameter using the and/or key and then repeat from instruction 3 onwards.
- 7 To save the modifications, press the key. To cancel the modifications wait approximately 40 seconds.

In the first case, the controller saves the changes, leaves the list of user parameters and returns to normal operation, displaying the inlet water temperature.

In the second case, the display starts flashing. Approximately 40 seconds later, the controller leaves the list of user parameters without saving the modifications. The inlet water temperature reappears on the display.

## Locking the controller keyboard

Once user parameter *H9* is set to 0, the following advanced features can no longer be carried out by means of the controller:

- modifying direct and user parameters (parameters can be displayed but not modified),
- resetting the timers.

When user parameter *H9* is set to 1, the above-described advanced features can be carried out using the controller.

To lock or unlock the controller keyboard, proceed as follows:

- 1 Enter the list of user parameters.  
Parameter code *rd* appears on the display.
- 2 Select parameter code *H9* using the and/or key.
- 3 Press the key to switch to the parameter value.
- 4 Select the appropriate setting using the and/or key.
- 5 Press the key to return to the list of parameter codes.

- 6 To adjust or to consult other user parameters before saving the modifications, select another user parameter using the **▲** and/or **▼** key and then repeat from instruction 3 onwards.
- 7 To save the modifications, press the **PRG** key. To cancel the modifications wait approximately 40 seconds.
- In the first case, the controller saves the changes, leaves the list of user parameters and returns to normal operation, displaying the inlet water temperature.
- In the second case, the display starts flashing. Approximately 40 seconds later, the controller leaves the list of user parameters without saving the modifications. The inlet water temperature reappears on the display.

### Defining the unit's serial address

To control the unit from a supervisory system, an address card (optional module) should be installed in the unit. The unit's serial address required for communication with the supervisory system is defined by parameter *HR*. The default, limit and step values for the serial address are:

- Default value *i*
- Limit values *i* to *i5*
- Step value *i*

To define the unit's serial address, proceed as follows:

- 1 Enter the list of user parameters.  
Parameter code *rd* appears on the display.
  - 2 Select parameter code *HR* using the **▲** and/or **▼** key.
  - 3 Press the **SEL** key to switch to the parameter value.
  - 4 Select the appropriate setting using the **▲** and/or **▼** key.
  - 5 Press the **SEL** key to return to the list of parameter codes.
  - 6 To adjust or to consult other user parameters before saving the modifications, select another user parameter using the **▲** and/or **▼** key and then repeat from instruction 3 onwards.
  - 7 To save the modifications, press the **PRG** key. To cancel the modifications wait approximately 40 seconds.
- In the first case, the controller saves the changes, leaves the list of user parameters and returns to normal operation, displaying the inlet water temperature.
- In the second case, the display starts flashing. Approximately 40 seconds later, the controller leaves the list of user parameters without saving the modifications. The inlet water temperature reappears on the display.

## TROUBLESHOOTING

This section provides useful information for diagnosing and correcting certain troubles which may occur in the unit.

Before starting the trouble shooting procedure, carry out a thorough visual inspection of the unit and look for obvious defects such as loose connections or defective wiring.

Before contacting your local dealer, read this chapter carefully, it will save you time and money.



When carrying out an inspection on the supply panel or on the switch box of the unit, always make sure that the circuit breaker of the unit is switched off.

When a safety device was activated, stop the unit and find out why the safety device was activated before resetting it. Under no circumstances safety devices may be bridged or changed to a value other than the factory setting. If the cause of the problem cannot be found, call your local dealer.

### Symptom 1: The unit does not start, but the **comp** LED lights up

POSSIBLE CAUSES	CORRECTIVE ACTION
The temperature setting is not correct.	Check the controller setpoint.
Power supply failure.	Check the voltage on the supply panel.
Blown fuse or interrupted protection device.	Inspect fuses and protection devices. Replace by fuses of the same size and type (refer to chapter "Electrical specifications" on page 2).
Loose connections.	Inspect connections of the field wiring and the internal wiring of the unit. Tighten all loose connections.
Shorted or broken wires.	Test circuits using a tester and repair if necessary.

### Symptom 2: The unit does not start, but the **comp** LED is flashing

POSSIBLE CAUSES	CORRECTIVE ACTION
The flowstart timer is still running.	The unit will start after approx. 15 seconds. Make sure that water is flowing through the evaporator.
The anti-recycling timer is still active.	The circuit can only start up after approximately 4 minutes.
The guard timer is still active.	The circuit can only start up after approximately 1 minute.

### Symptom 3: The unit does not start and the **comp** LED does not light up

POSSIBLE CAUSES	CORRECTIVE ACTION
One of the following safety devices is activated: <ul style="list-style-type: none"> <li>• Reverse phase protector</li> <li>• Overcurrent relay (K*S)</li> <li>• Discharge thermal protector (Q*D)</li> <li>• Evaporating temperature thermostat (S*T)</li> <li>• Flow switch (S10L)</li> <li>• High pressure switch (S*HP)</li> </ul>	Check on the controller and refer to symptom "4. One of the following safety devices is activated". Refer to the explanation of the digital controller in the chapter "Resetting alarms" on page 7.
The unit is in anti-freeze alarm.	Check on the controller and refer to symptom "4. One of the following safety devices is activated". Refer to the explanation of the digital controller in the chapter "Resetting alarms" on page 7.
The remote ON/OFF input is enabled and the remote switch is off.	Put the remote switch on or disable the remote ON/OFF input.
The keyboard is locked. The user parameter <i>H9</i> is set to <i>0</i> .	Unlock the controller keyboard.

### Symptom 4: One of the following safety devices is activated

Symptom 4.1: Overcurrent relay of compressor	
POSSIBLE CAUSES	CORRECTIVE ACTION
Failure of one of the phases.	Check fuses on the supply panel or measure the supply voltage.
Voltage too low.	Measure the supply voltage.
Overload of motor.	Reset. If the failure persists, call your local dealer.
<b>RESET</b> <i>Push the red button on the over-current relay inside the switch box. The controller still needs to be reset.</i>	
Symptom 4.2: Low pressure switch or anti-freeze alarm	
POSSIBLE CAUSES	CORRECTIVE ACTION
Water flow to water heat exchanger too low.	Increase the water flow.
Shortage of refrigerant.	Check for leaks and refill refrigerant, if necessary.
Unit is working out of its operation range.	Check the operation conditions of the unit.
Inlet temperature to the water heat exchanger is too low.	Increase the inlet water temperature.
Flow switch is not working or no water flow.	Check the flow switch and the water pump.
<b>RESET</b> <i>After pressure rise, the low pressure switch resets automatically, but the controller still needs to be reset.</i>	

Symptom 4.3: High-pressure switch	
POSSIBLE CAUSES	CORRECTIVE ACTION
Condenser fan does not operate properly.	Check that the fans turn freely. Clean if necessary.
Dirty or partially blocked condenser.	Remove any obstacle and clean condenser coil using brush and blower.
Inlet air temperature of the condenser is too high.	The air temperature measured at the inlet of the condenser should not exceed 43°C.
<b>RESET</b> <i>After pressure decrease, the high pressure switch resets automatically, but the controller still needs to be reset.</i>	
Symptom 4.4: Reverse phase protector is activated	
POSSIBLE CAUSES	CORRECTIVE ACTION
Two phases of the power supply are connected in the wrong phase position.	Invert two phases of the power supply (by licensed electrician).
One phase is not connected properly.	Check the connection of all phases.
<b>RESET</b> <i>After inverting two phases or fixing the power supply cables properly, the protector is reset automatically, but the unit still needs to be reset.</i>	
Symptom 4.5: Discharge thermal protector is activated	
POSSIBLE CAUSES	CORRECTIVE ACTION
Unit is working outside the operation range.	Check the operation condition of the unit.
<b>RESET</b> <i>After temperature decrease, the thermal protector resets automatically but the controller still needs to be reset.</i>	
Symptom 4.6: Flow switch is activated	
POSSIBLE CAUSES	CORRECTIVE ACTION
No water flow.	Check the water pump.
<b>RESET</b> <i>After finding the cause, the flow switch is reset automatically, but the controller still needs to be reset.</i>	

#### Symptom 5: Unit stops soon after operation

POSSIBLE CAUSES	CORRECTIVE ACTION
One of the safety devices is activated.	Check safety devices (refer to symptom "4. One of the following safety devices is activated").
Voltage is too low.	Test the voltage in the supply panel and, if necessary, in the electrical compartment of the unit (voltage drop due to supply cables is too high).

#### Symptom 6: Unit runs continuously and the water temperature remains higher than the temperature set on the controller

POSSIBLE CAUSES	CORRECTIVE ACTION
The temperature setting on the controller is too low.	Check and adjust the temperature setting.
The heat production in the water circuit is too high.	The cooling capacity of the unit is too low. Call your local dealer.
Water flow is too high.	Recalculate the water flow.

#### Symptom 7: Excessive noises and vibrations of the unit

POSSIBLE CAUSES	CORRECTIVE ACTION
Unit has not been fixed properly.	Fix the unit as described in the installation manual.

## MAINTENANCE

In order to ensure optimal availability of the unit, a number of checks and inspections on the unit and the field wiring have to be carried out at regular intervals.

If the unit is used for air conditioning application, the described checks should be executed at least once a year. In case the unit is used for other applications, the checks should be executed every 4 months.



Before carrying out any maintenance or repair activity, always switch off the circuit breaker on the supply panel, remove the fuses or open the protection devices of the unit.

Do never clean the unit with water under pressure.

### Important information regarding the refrigerant used

This product contains fluorinated greenhouse gases covered by the Kyoto Protocol.

Refrigerant type: R407C

GWP<sup>(1)</sup> value: 1652.5

<sup>(1)</sup> GWP = global warming potential

Periodical inspections for refrigerant leaks may be required depending on European or local legislation. Please contact your local dealer for more information.

### Maintenance activities



The wiring and power supply must be checked by a licensed electrician.

- **Field wiring and power supply**
  - Check the power supply voltage on the local supply panel. The voltage should correspond to the voltage marked on the identification label of the unit.
  - Check the connections and make sure they are properly fixed.
  - Check the proper operation of the circuit breaker and the earth leak detector provided on the local supply panel.
- **Internal wiring of the unit**

Visually check the switch box on loose connections (terminals and components). Make sure that the electrical components are not damaged or loose.
- **Earth connection**

Make sure that the earth wires are still connected properly and that the earth terminals are tightened.
- **Refrigerant circuit**
  - Check for leaks inside the unit. In case a leak is detected, call your local dealer.
  - Check the working pressure of the unit. Refer to paragraph "Switching the EWLP unit on" on page 6.
- **Compressor**
  - Check on oil leaks. If there is an oil leak, call your local dealer.
  - Check for abnormal noises and vibrations. If the compressor is damaged, call your local dealer.
- **Water supply**
  - Check if the water connection is still well fixed.
  - Check the water quality (refer to the installation manual of the unit for specifications of the water quality).

### Disposal requirements

Dismantling of the unit, treatment of the refrigerant, of oil and of other parts must be done in accordance with relevant local and national legislation.

**Saturated temperature**

The figures below represent the average saturated temperature of R407C in relation to the pressure readout.

**High pressure side**

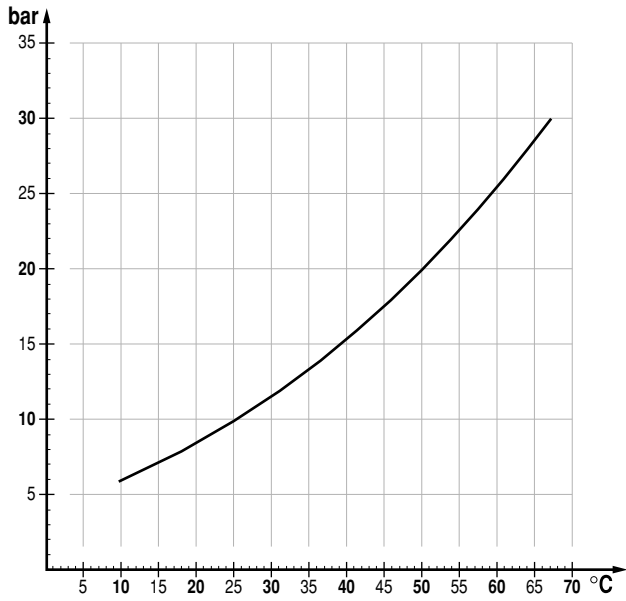

**Low pressure side**



conditions:

- high pressure = 20 bar
- subcool = 3°C

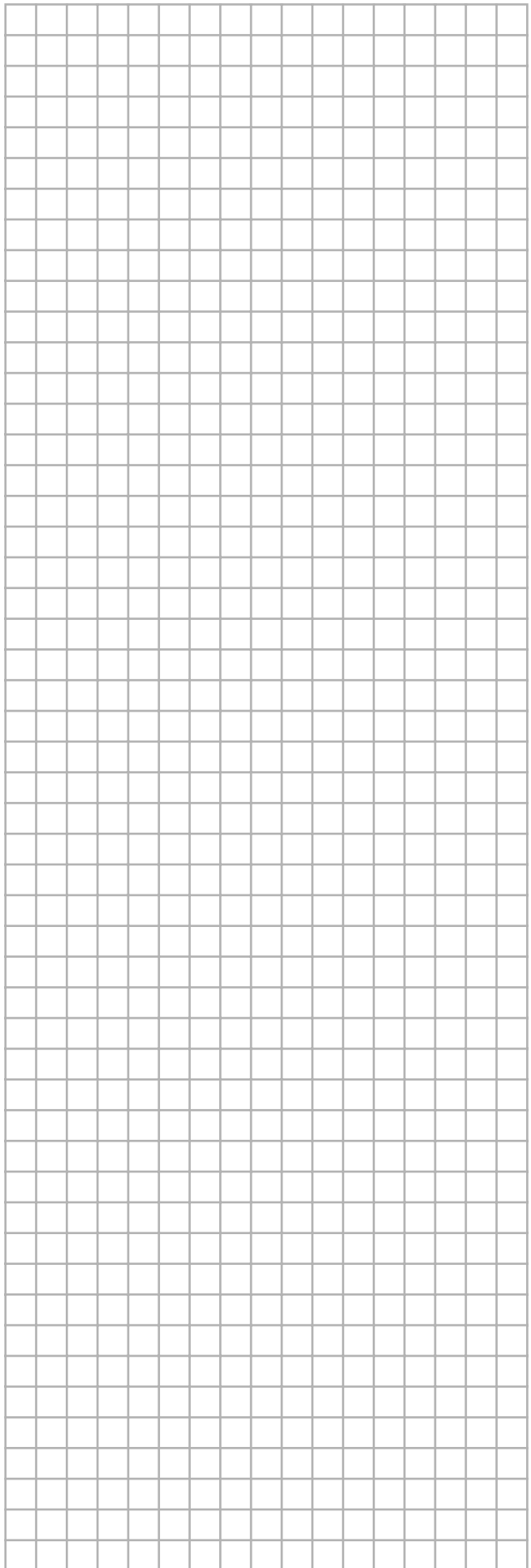

# NOTES

