VRV SYSTEM Inverter Air Conditioners

MODELS

Ceiling-mounted Duct type**FXMQ20PVE****FXMQ25PVE****FXMQ32PVE****FXMQ40PVE****FXMQ50PVE****FXMQ63PVE****FXMQ80PVE****FXMQ100PVE****FXMQ125PVE****FXMQ140PVE**

English

Deutsch

Français

Español

Italiano

Ελληνικά

Nederlands

Portugues

Русский

中文
(繁體)中文
(简体)

Thank you for purchasing this Daikin air conditioner. Carefully read this operation manual before using the air conditioner. It will tell you how to use the unit properly and help you if any trouble occurs. This manual explains about the indoor unit only. Use it along with the operation manual for the outdoor unit. After reading the manual, file it away for future reference.

Vielen Dank für den Kauf einer Klimaanlage von Daikin. Lesen Sie dieses Betriebshandbuch vor Inbetriebnahme der Klimaanlage sorgfältig durch. Sie erfahren hier, wie die Einheit korrekt genutzt wird, und es ist Ihnen bei Störungen behilflich. Das Betriebshandbuch erklärt nur das Innenaggregat. Verwenden Sie es deshalb zusammen mit dem entsprechenden Handbuch für das Aussenaggregat. Wenn Sie das Handbuch durchgelesen haben, bewahren Sie es gut auf, damit Sie auch später noch nachschlagen können.

Nous vous remercions pour votre acquisition de ce système de climatisation Daikin. Lisez attentivement ce manuel avant d'utiliser le climatiseur. Il vous expliquera comment vous servir correctement de l'appareil et vous guidera en cas de problème. Ce manuel ne décrit que l'unité intérieure. Utilisez-le avec le manuel de l'unité extérieure. Lorsque vous aurez lu le manuel, rangez-le afin de pouvoir vous y référer ultérieurement.

Le agradecemos la compra de este acondicionador de aire Daikin.

Lea cuidadosamente el manual de funcionamiento antes de utilizar el acondicionador de aire. Dicho manual le indicará cómo utilizar adecuadamente la máquina y le ayudará en caso de avería. Este manual describe sólo la unidad interior. Utilice conjuntamente con el manual de instrucciones de la unidad exterior. Después de leer el manual, consérvelo para consultas futuras.

La ringraziamo di aver acquistato questo condizionatore d'aria Daikin

Leggere attentamente questo manuale prima di utilizzare il condizionatore. Contiene le istruzioni per usare correttamente l'unità e per rimediare ad eventuali problemi di funzionamento. Il presente manuale è valido per l'unità interna. Utilizzarlo congiuntamente al manuale d'istruzioni per l'unità esterna. Dopo averlo letto, conservare il manuale per consultazioni future.

Σας ευχαριστούμε που αγοράσατε αυτή την κλιματιστική συσκευή της Daikin.

Διαβάστε προσεκτικά αυτό το εγχειρίδιο χρήσης πριν χρησιμοποιήσετε την κλιματιστική συσκευή. Θα σας εξηγήσει πώς να χρησιμοποιείτε τη μονάδα σωστά και θα σας βοηθήσει αν παρουσιαστεί κάποιο πρόβλημα. Αυτό το εγχειρίδιο περιγράφει μόνο την εσωτερική μονάδα. Χρησιμοποιήστε το μαζί με το εγχειρίδιο λειτουργίας για την εξωτερική μονάδα. Αφού διαβάσετε το εγχειρίδιο, φυλάξτε το για μελλοντική χρήση.

Wij danken u voor de aankoop van deze Daikin-airconditioner.

Lees deze bedrijfshandleiding aandachtig door voordat u de airconditioner gebruikt. Het omvat uitleg over het correcte gebruik van de unit en biedt hulp in geval een storing mocht optreden. Deze handleiding beschrijft alleen het binnentoestel. Gebruik ze samen met de bedieningshandleiding voor het buitentoestel. Gebruik deze handleiding voor verdere raadpleging.

Obrigado pela sua compra deste aparelho de ar condicionado Daikin.

Leia com atenção este manual de operação antes de proceder à utilização do aparelho de ar condicionado. Este indicar-lhe-á como deverá utilizar a unidade correctamente e ajudá-lo-á no caso de surgir qualquer problema. Este manual apenas contém explicações sobre a unidade interior. Use-o em conjunto com o manual de operação da unidade exterior. Depois de ler o manual, guarde-o a fim de o poder consultar caso venha a ser preciso.

Благодарим за покупку кондиционера Daikin. До начала работы с кондиционером внимательно изучите данное руководство по эксплуатации. В нем излагаются правила пользования и приводятся рекомендации по поиску и устранению неисправностей. В данном руководстве рассматривается только комнатный блок. Используйте его вместе с руководством для наружного блока. После изучения руководства сохраните его для справки.

感謝您購買大金的空調機。

在使用本空調機之前，請仔細閱讀本使用說明書。本說明書說明空調機的正确的使用方法，以及發生故障時的對應措施。本使用說明書為室內機專用的說明書，請同時參照閱讀室外機附帶的使用說明書。

閱讀完畢本說明書以後，請妥善保管，以備需要時查閱。

感谢您购买大金的空调机。

在使用本空调机之前，请仔细阅读本使用说明书。本说明书说明空调机的正确使用方法，以及发生故障时的对应措施。本使用说明书为室内机专用的说明书，请同时参照阅读室外机附带的说明书。

阅读完毕本说明书以后，请妥善保管，以备需要时查阅。

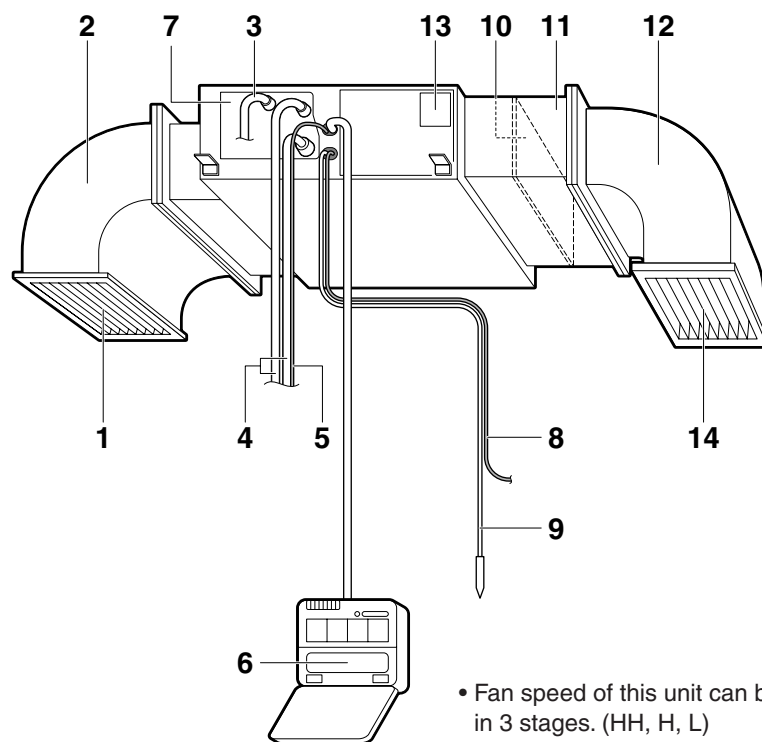

• Fan speed of this unit can be selected in 3 stages. (HH, H, L)

Important information regarding the refrigerant used

This product contains fluorinated greenhouse gases covered by the Kyoto Protocol.

Refrigerant type	R410A
GWP ⁽¹⁾ value	1975

⁽¹⁾ GWP = global warming potential

Periodical inspections for refrigerant leaks may be required depending on European or local legislation. Please contact your local dealer for more information.

SAFETY PRECAUTIONS

To gain full advantage of the air conditioner's functions and to avoid malfunction due to mishandling, we recommend that you read this instruction manual carefully before use.

- This air conditioner is classified under "appliances not accessible to the general public". (The unit is to be installed at a minimum height of 2.5 m.)
- The precautions described herein are classified as **WARNING** and **CAUTION**. They both contain important information regarding safety. Be sure to observe all precautions without fail.

 **WARNING** Failure to follow these instructions properly may result in personal injury or loss of life.

 **CAUTION** Failure to observe these instructions properly may result in property damage or personal injury, which may be serious depending on the circumstances.

- After reading, keep this manual in a convenient place so that you can refer to it whenever necessary. If the equipment is transferred to a new user, be sure also to hand over the manual.

 **WARNING**

- Do not allow children to mount on the outdoor unit or avoid placing any object on it. Falling or tumbling may result in injury.

 **CAUTION**

- Do not place objects in direct proximity of the outdoor unit and do not let leaves and other debris accumulate around the unit.

Leaves are a hotbed for small animals which can enter the unit. Once in the unit, such animals can cause malfunctions, smoke or fire when making contact with electrical parts.

- Do not block air inlets nor outlets. Impaired air flow may result in insufficient performance or trouble.

NAME OF PARTS

Refer to figure 1 on page [1]

1. Air outlet (Field supply)
2. Exhaust duct (Field supply)
3. Drain pipe
4. Connection piping
5. Transmission wiring
6. Remote controller (Sold separately)

7. Drain discharge device (built-in)
Discharges indoor moisture removed during cooling operation.
8. Power line
9. Grounding wire
This wire releases electricity from the indoor unit to the ground in order to prevent electric shock or fire.
10. Air filter (inside filter chamber) (Sold separately)
11. Suction filter chamber (Sold separately)
12. Suction duct (Field supply)
13. Machine nameplate
The nameplate is imprinted with the machine name and specifications.
14. Suction grille (Field supply)

MAINTENANCE

 **WARNING**

- Only a qualified person is allowed to perform maintenance without daily maintenance.
- Before touching any of connection wirings, be sure to turn off all power supply switches.
- Do not use flammable materials (e.g., hairspray or insecticide) near the product.
Do not clean the product with organic solvents such as paint thinner.
The use of organic solvents may cause crack damage to the product, electric shocks, or fire.
- Contact professional personnel about attachment of accessories and be sure to use only accessories specified by the manufacturer.
If a defect results from your own workmanship, it may result in water leaks, electric shock or fire.

 **CAUTION**

- Before cleaning, be sure to stop unit operation, turn the breaker off or remove the power cord.
Otherwise, an electric shock and injury may result.
- Do not wash the air conditioner with water, as this may result in electric shocks or fire.
- Consult your dealer regarding cleaning the inside of the air conditioner.
Improper cleaning may cause breakage of plastic parts, water leakage and other damage as well as electric shocks.
- Watch your steps at the time of air filter cleaning or inspection.
High-place work is required, to which utmost attention must be paid.
If the scaffold is unstable, you may fall or topple down, thus causing injury.

HOW TO CLEAN THE AIR FILTER

(The air filter is an optional accessory.)

Clean the air filter when the display shows "  " (TIME TO CLEAN AIR FILTER).

- This message is displayed once the unit has operated for a certain amount of time.
- Always clean the air filter at the beginning of the heating or cooling season.
(Dust and dirt in the air filter reduce airflow, lowering the unit's capacity.)
- Clean the air filter more frequently when using the unit in a dirty environment.

NOTES

- Do not remove the air filter for other than cleaning purposes.
Doing so may cause damage to the unit.
(The unit does not include an air filter as standard equipment.)
- Do not install any object other than a proper air filter in the suction inlet (for example, a paper towel). Doing so may result in degraded performance and cause freezing or water leakage.

1. Press the **FILTER SIGN RESET BUTTON** of the **remote controller** after the air filter is cleaned and attached.

The “” (TIME TO CLEAN AIR FILTER) display turns OFF.

Refer to the operation manual provided with the outdoor unit for the positions of the “” (TIME TO CLEAN AIR FILTER) display and FILTER SIGN RESET BUTTON.

HOW TO CLEAN AIR OUTLET AND OUTSIDE PANELS (Field supply)

1. Clean with soft cloth.
2. When it is difficult to remove stains, use water or neutral detergent.

NOTES

- Do not use gasoline, benzene, thinner, polishing powder, liquid insecticide. It may cause discoloring or warping.
- Do not let the indoor unit get wet. It may cause an electric shock or a fire.
- Do not use hot water of 50°C or higher, as doing so may result in discoloration or deformation.

DAIKIN INDUSTRIES, LTD.

Head office:

Umeda Center Bldg., 2-4-12, Nakazaki-Nishi,
Kita-ku, Osaka, 530-8323 Japan

Tokyo office:

JR Shinagawa East Bldg., 2-18-1, Konan,
Minato-ku, Tokyo, 108-0075 Japan

DAIKIN EUROPE NV

Zandvoordestraat 300, B-8400 Oostende, Belgium

大金工業株式会社

總公司

日本大阪府大阪市北區中崎西二丁目4番12號
梅田中心大廈 郵遞區號 530-8323

東京分公司

日本東京都港區港南二丁目18番1號
JR品川東大廈 郵遞區號108-0075

大金工業株式会社

总公司

日本大阪府大阪市北區中崎西二丁目4番12号
梅田中心大廈 邮政编码 530-8323

东京分公司

日本东京都港区港南二丁目18番1号
JR品川东大厦 邮政编码108-0075