

DAIKIN



OPERATION MANUAL

Split system air conditioners

FFQ25B7V1B
FFQ35B7V1B
FFQ50B7V1B
FFQ60B7V1B

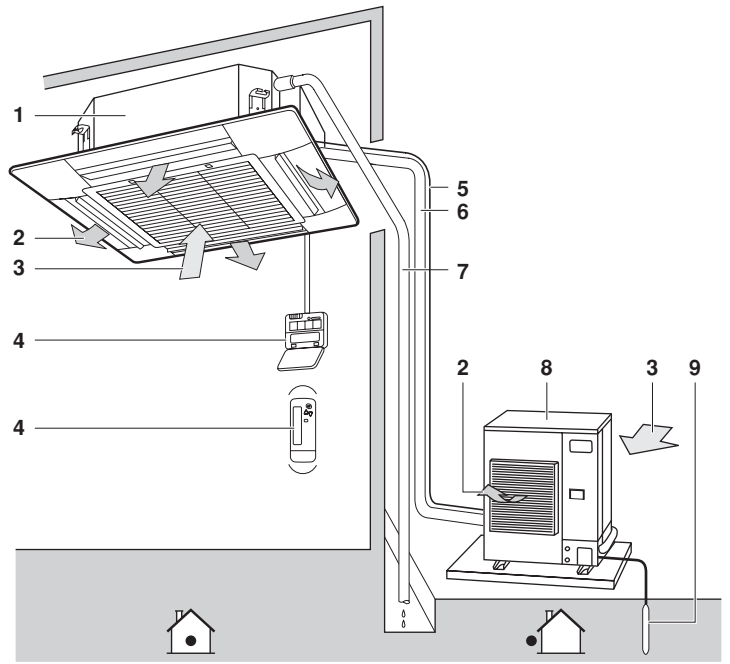
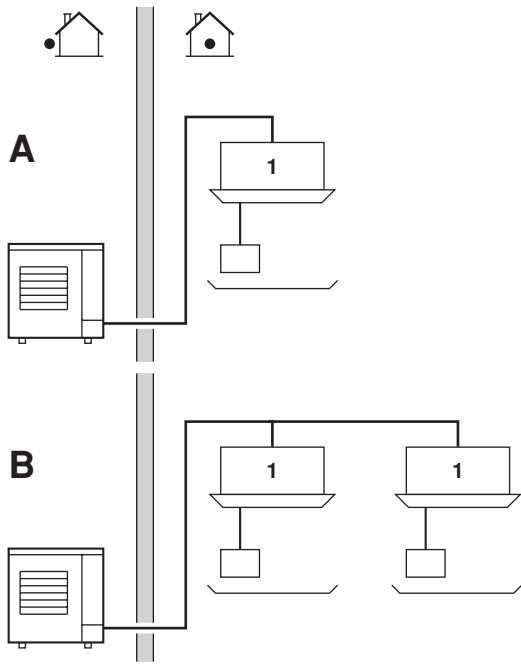

1

2

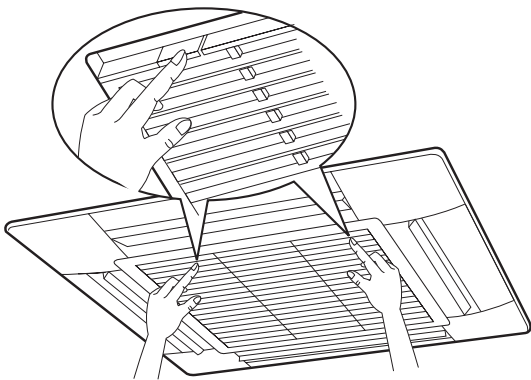

3

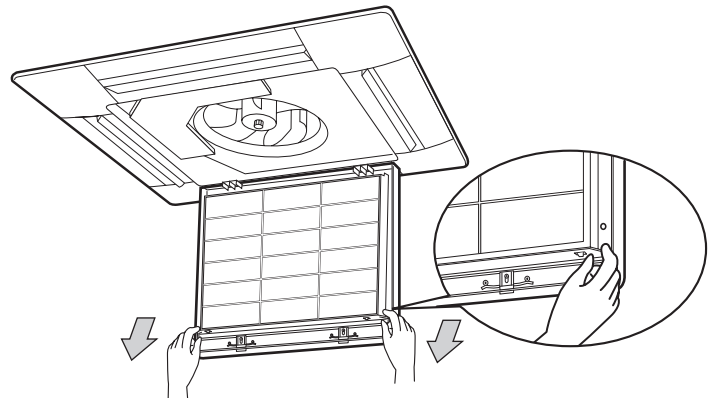

4

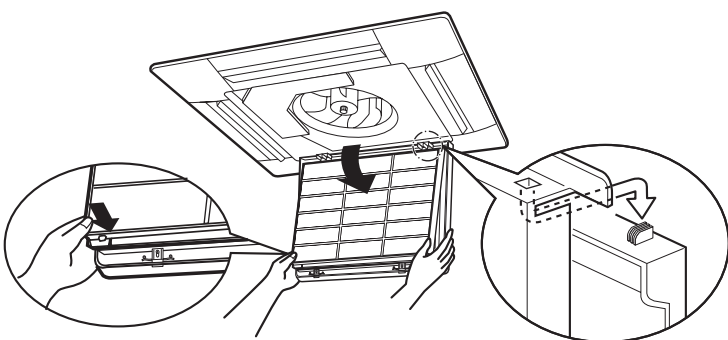

5

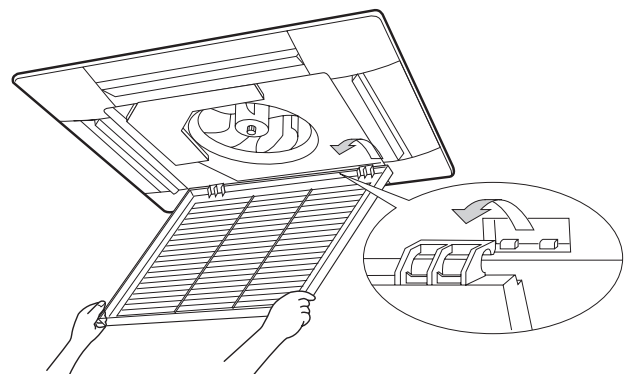

6

CONTENTS

	Page
What to do before operation	1
Names and functions of parts.....	1
Operation range.....	1
Installation site.....	2
Operation procedure.....	2
Optimum operation	2
Not a malfunction of the air conditioner	2
Troubleshooting	4
Maintenance	4



THANK YOU FOR PURCHASING THIS DAIKIN AIR CONDITIONER. CAREFULLY READ THIS OPERATION MANUAL BEFORE USING THE AIR CONDITIONER. IT WILL TELL YOU HOW TO USE THE UNIT PROPERLY AND HELP YOU IF ANY TROUBLE OCCURS. AFTER READING THE MANUAL, FILE IT AWAY FOR FUTURE REFERENCE.

WHAT TO DO BEFORE OPERATION (See figure 1)

This operation manual is for the following systems with standard control. Before initiating operation, contact your Daikin dealer for the operation manual that corresponds to your system.

NOTE



These units can be controlled by a remote controller. Refer to the manual of the remote controller for more information.

If your installation has a customized control system, ask your Daikin dealer for the operation that corresponds to your system.

- A** Pair system
- B** Multi system
- 1** Unit with remote controller

- Heat pump type
This system provides cooling, heating, automatic, and fan operation modes.
- Straight cooling type
This system provides cooling, and fan operation modes.

NAMES AND FUNCTIONS OF PARTS (See figure 2)

- 1 Indoor unit
- 2 Discharged air
- 3 Inlet air
- 4 Remote controller
- 5 Connection electric wire
- 6 Refrigerant piping
- 7 Drain pipe
- 8 Outdoor unit
- 9 Ground wire
Wire to ground outdoor unit to prevent electrical shocks.



- Never let the indoor unit and the remote controller get wet.
It may cause an electric shock or a fire.
- Never use flammable spray such as hair spray, lacquer or paint near the unit.
It may cause a fire.
- Never replace a fuse with that of a wrong ampere rating or other wires when the fuse blows out.
Use of wire or copper wire may cause the unit to break down or cause a fire.
- Never touch the air outlet or the horizontal blades while the swing flap is in operation.
Fingers may become caught or the unit may break down.
- Never insert objects such as sticks into the air inlet or outlet. It is dangerous for an object to touch the fan when it is turning at high speed.
- Never remove the fan guard of the outdoor unit.
The rotating fan at high speed without the guard is very dangerous.
- Never inspect or service the unit by yourself.
Ask a qualified service person to perform this work.

OPERATION RANGE

If operating outside the following conditions, safety devices may activate, rendering the air conditioner inoperable or may cause the indoor unit to sweat.

The setting temperature range of the remote controller is 16°C~32°C.

	🏠 °C		💧 %	🏠 °C
	°C DB	°C WB		
RS50-60 RKS25-35-50-60 RXS25-35-50-60	21~32 14~23	≤80%	-10~46 ^(*)	
3MKS50 4MKS58-75-90 3MXS52 4MXS68-80	21~32 14~23	≤80%	-10~46	

☀️	🏠 °C		🏠 °C	
	°C DB	°C WB	°C DB	°C WB
RXS25-35	10~30	-10~24 -15~20	-14~24 -15~18	
RXS50-60	10~30	-10~21 -15~15.5		

(DB=dry bulb, WB=wet bulb, ❄️=cooling, ☀️=heating, 🏠=indoor, 🏠=outdoor, 🌡️°C=temperature, 💧=humidity)

(*) For Australian models: -5~46°C

INSTALLATION SITE



- Never place anything under the indoor unit that you don't want to get wet. The unit may sweat when the humidity is over 80% or when the drain outlet is clogged.
- Never place other heating equipment directly beneath the indoor unit. Subject to deformation caused by heat.
- Do not place TV, radio, stereo, etc. within 1 meter from the indoor unit and remote controller. Doing so may cause interference in the picture or sound.

NAME AND FUNCTION OF EACH SWITCH AND DISPLAY ON THE REMOTE CONTROLLER



The information specifically for the Australian model can be found in "ANNEX I" on page 6.

For the European model, refer to the operation manual delivered with the remote controller.

OPERATION PROCEDURE



- If a function that is not available is selected, the message NOT AVAILABLE will appear.
- Operating procedure varies with heat pump type and straight cooling type. Contact your Daikin dealer to confirm your system type.
- To protect the unit, turn on the main power switch 6 hours before operation.
- If the main power supply is turned off during operation, operation will restart automatically after the power turns back on again.

NOTE



Set the temperature within the ranges mentioned under "Operation range" on page 1.

Precautions for group control system or two remote controller control system

This system provides two other control systems beside individual control (one remote controller controls one indoor unit) system. Confirm the following if your unit is of the following control system type.

- Group control system
One remote controller controls up to 16 indoor units. All indoor units are equally set.
- Two remote controller control system
Two remote controllers control one indoor unit (In case of group control system, one group of indoor units). The unit is individually operated.

NOTE



Contact your Daikin dealer in case of changing the combination or setting of group control and two remote controller control systems.



Information specifically for the Australian model can be found in "ANNEX II" on page 7.

For the European model, refer to the operation manual delivered with the remote controller.

OPTIMUM OPERATION

Observe the following precautions to ensure the system operates properly.

- Adjust the air outlet properly and avoid direct air flow to room inhabitants.
- Adjust the room temperature properly for a comfortable environment. Avoid excessive heating or cooling.
- Prevent direct sunlight from entering a room during cooling operation by using curtains or blinds.
- Keep doors and windows closed. If the doors and windows remain open, room air will flow out and decrease the effect of cooling and heating.
- Never place objects near the air inlet and the air outlet of the unit. It may retard effectiveness or cause operation to stop.
- Turn off the main power supply switch when not using for long periods of time. Electricity is consumed as long as the switch is on. Turn off the main power supply switch in order to save energy. Turn on the main power supply switch 6 hours before restarting operation in order to ensure smooth operation. (Refer to "Maintenance" on page 4.)
- When the display shows "" (TIME TO CLEAN AIR FILTER), have a qualified service person to clean the filters. (Refer to "Maintenance" on page 4.)

NOT A MALFUNCTION OF THE AIR CONDITIONER

The following symptoms do not indicate air conditioner malfunction.

The system does not operate

- The system does not restart immediately after the ON/OFF button is pressed.
If the OPERATION lamp lights, the system is in its normal operating condition.
It does not restart immediately because one of its safety devices actuates to prevent the system from being overloaded.
The system will turn on again automatically after three minutes.
- The system does not restart immediately when the TEMPERATURE SETTING button is returned to its former position after pushing.
It does not restart immediately because one of its safety devices actuates to prevent the system from being overloaded.
The system will turn on again automatically after three minutes.
- The system does not start when the display shows "" (EXTERNAL CONTROL ICON) and it flashes for a few seconds after pressing an operation button.
This is because the system is controlled or disabled by another controller with a higher priority.
When the display flashes, it indicates that the system cannot be controlled by this indoor unit.
- The system does not start immediately after the power supply is turned on.
Wait one minute until the micro computer is prepared for operation.

- The outdoor unit has stopped.
This is because the room temperature has reached the set temperature. The unit switches to fan operation.

" (EXTERNAL CONTROL ICON) is displayed on the remote controller and the actual operation is different from the remote controller setting.

For multi split models, the micro computer executes the following control depending on the operation mode of other indoor units.

- Before you start to operate, the other indoor unit(s) is (are) already operating. When the operation mode of this unit is different from your choice, the indoor unit of your room may be put in waiting condition. (Fan: Stop, Horizontal flap: Horizontal position)

Your room	Operation mode			
	Other room(s)	Other room(s)	Other room(s)	Other room(s)
	Cooling	Dry	Fan only	Heating
Cooling	O	O	O	W
Dry	O	O	O	W
Fan only	O	O	O	W
Heating	W	W	W	O

O: your unit can operate
W: your unit in waiting mode

- When the total cooling capacity of all indoor units which are operating is beyond the capacity limit of the outdoor unit, your indoor unit will be put in waiting condition. (Fan and horizontal flap: Same as setting: (cooling only model only))
- After cooling mode operation of the unit of your room, when other unit(s) start to operate, the unit of your room may operate as follows: Fan: L tab, Horizontal flap: Horizontal position.
- The fan speed is different from the setting. Pressing the fan speed control button does not change the fan speed.
When the room temperature reaches the set temperature in heating mode, the capacity supply from the outdoor unit has stopped and the indoor unit operates in fan only mode (L tab). In case of multi split, the indoor unit alternately operates fan stop and fan only mode (L tab).
This is to prevent the cool air from being blown directly onto anyone present in the room.

Air blow direction is not as specified

- Actual air blow direction is not as shown on the remote controller.
- Automatic swing setting does not work.
Australia: Refer to "Air flow direction adjust" on page 7.
Europe: Refer to the manual of the remote controller.

White mist comes out of a unit

- When humidity is high during cooling operation (In oily or dusty places).
If the inside of an indoor unit is extremely contaminated, the temperature distribution inside a room becomes uneven. It is necessary to clean the inside of the indoor unit. Ask your Daikin dealer for details on cleaning the unit. This operation requires a qualified service person.
- When the system is changed over to HEATING OPERATION after DEFROST OPERATION.
Moisture generated by DEFROST becomes steam and exits.

Noise of air conditioners

- A ringing sound is heard after the unit is started. This sound is generated by the temperature regulator operation. It will quiet down after about a minute.
- A continuous low "hissing" sound is heard when the system is in COOLING or DEFROST OPERATION.
This is the sound of refrigerant gas flowing through both indoor and outdoor units.
- A "hissing" sound which is heard at the start or immediately after the stop of operation or which is heard at the start or immediately after the stop of DEFROST OPERATION.
This is the noise of refrigerant caused by flow stop and flow change.
- A continuous low "swishing" sound is heard when the system is in COOLING OPERATION or at a stop.
The noise is heard when the drain pump is in operation.
- A "squeaking" sound is heard when the system is in operation or after the stop of operation.
Expansion and contraction of plastic parts caused by temperature change makes this noise.

Dust from the units

- Dust may blow out from the unit after starting operation from long resting time. Dust absorbed by the unit blows out.

The units give off odours

- The unit absorbs the smell of rooms, furniture, cigarettes, etc., and then emits them.

The liquid crystal display of the remote controller shows "88"

- Happens immediately after the main power supply switch is turned on.
Shows that the remote controller is in normal condition.
Continues temporarily.

TROUBLESHOOTING

If one of the following malfunctions occurs, take the measures shown below and contact your Daikin dealer.

The system must be repaired by a qualified service person.

- If a safety device such as a fuse, a breaker, or an earth leakage breaker frequently actuates, or ON/OFF switch does not properly work.
Measure: Turn off the main power switch.
- If water leaks from unit.
Measure: Stop the operation.
- If the display "🔍" (INSPECTION), "UNIT No.", and the OPERATION lamp flashes and the "MALFUNCTION CODE" appears.
Measure: Notify your Daikin dealer and inform him/her of the display.

If the system does not operate properly, except for the above mentioned case, and none of the above mentioned malfunctions are evident, investigate the system according to the following procedures.

If the system does not operate at all.

- Check if there is a power failure.
Wait until power is restored. If power failure occurs during operation, the system automatically restarts immediately after the power supply recovers.
- Check if the fuse has blown or breaker has been tripped.
Change the fuse or set the breaker.

If the system stops operating after operation is complete.

- Check if the air inlet or outlet of outdoor or indoor unit is blocked by obstacles.
Remove the obstacle and make it well-ventilated.
- Check if the air filter is clogged.
Ask a qualified service person to clean the air filter.

The system operates but it does not sufficiently cool or heat.

- If the air inlet or outlet of the indoor or the outdoor unit is blocked with obstacles.
Remove the obstacle and make it well-ventilated.
- If the air filter is clogged.
Ask a qualified service person to clean the air filter.
- If the set temperature is not proper. (Refer to the manual of the remote controller)
- If the FAN SPEED CONTROL button is set to LOW SPEED. (Refer to the manual of the remote controller)
- If the air flow angle is not proper. (Refer to the manual of the remote controller)
- If the doors or the windows are open. Shut doors or windows to prevent wind from coming in.
- If direct sunlight enters the room (when cooling).
Use curtains or blinds.
- When there are too many inhabitants in the room. Cooling effect decreases if heat gain of the room is too large.
- If the heat source of the room is excessive (when cooling).
Cooling effect decreases if heat gain of the room is too large.

MAINTENANCE

IMPORTANT

- ONLY A QUALIFIED SERVICE PERSON IS ALLOWED TO PERFORM MAINTENANCE.
- BEFORE OBTAINING ACCESS TO TERMINAL DEVICES, ALL POWER SUPPLY CIRCUITS MUST BE INTERRUPTED.
- DO NOT USE WATER OR AIR OF 50°C OR HIGHER FOR CLEANING AIR FILTERS AND OUTSIDE PANELS.
- WHEN CLEANING THE HEAT EXCHANGER, BE SURE TO REMOVE THE SWITCHBOX, FAN MOTOR AND DRAIN PUMP. WATER OR DETERGENT MAY DETERIORATE THE INSULATION OF ELECTRIC COMPONENTS AND RESULT IN BURN-OUT OF THESE COMPONENTS.

See figure 2

- 1 Indoor unit
- 2 Discharged air
- 3 Inlet air
- 4 Remote controller
- 5 Connection electric wire
- 6 Refrigerant piping
- 7 Drain pipe
- 8 Outdoor unit
- 9 Ground wire
Wire to ground outdoor unit to prevent electrical shocks.

How to clean the air filter

Clean the air filter when the display shows "🔍" (TIME TO CLEAN AIR FILTER).

Increase the frequency of cleaning if the unit is installed in a room where the air is extremely contaminated.

(As a yardstick for yourself, consider cleaning the filter once a half year.)

If dirt becomes impossible to clean, change the air filter. (Air filter for exchange is optional.)

1. Open the suction grill
Push both knobs simultaneously and carefully lower the grille. (Identical procedure for closing.) (See figure 3)
2. Remove the air filters
Pull the hook of the air filter out diagonally downward and remove the filter. (See figure 4)
3. Clean the air filter
Use a vacuum cleaner or wash the air filter with water. When the air filter is very dirty, use a soft brush and neutral detergent.

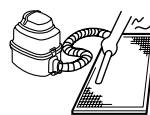

Remove water and dry in the shade.

4. Fix the air filter
Attach the air filter to the suction grill by hanging it to the projected portion above the suction grill.
Press the bottom of the air filter against the projections on the bottom of the grille to snap the air filter into its place. (See figure 5)
5. Shut the air inlet grill
Refer to item No. 1.
6. After turning power on, press the FILTER SIGN RESET button
The "TIME TO CLEAN AIR FILTER" display disappears.
(For details, refer to the operation manual of the outdoor unit.)

NOTE Do not remove the air filter except when cleaning. Unnecessary handling may damage the filter.

How to clean the air outlet and outside panels

- Clean with a soft cloth.
- When it is difficult to remove stains, use water or neutral detergent.
- When the blade is extremely contaminated, remove it as below and clean it.

NOTE



- Do not use gasoline, benzene, thinner, polishing powder nor liquid insecticide. It may cause discolouring or warping.
- Do not let the indoor unit get wet. It may cause electric shock or fire.

How to clean the suction grill

1. Open the suction grill
Push both knobs simultaneously and carefully lower the grille. (Identical procedure for closing.) (See figure 3)
2. Detach the suction grill
Open the suction grill 45 degrees and lift it upward. (See figure 6)
3. Detach the air filter
See the figure in item No. 2 in chapter "How to clean the air filter" on page 4.
4. Clean the suction grill
Wash it with a soft brush and neutral detergent, and dry thoroughly.



NOTE



When the suction grill is very dirty, use a typical kitchen cleaner and let it sit for about 10 minutes. Then, wash it with water.

5. Fix the air filter
See the figure in item No. 4 in chapter "How to clean the air filter" on page 4.
6. Re-attach the suction grill
See item No. 2.
7. Close the suction grill
See item No. 1.

Start-up after a long stop

- Confirm the following.
 - Check that the air inlet and outlet are not blocked. Remove any obstacle.
 - Check if the earth is connected.
- Clean the air filter and outside panels.
 - After cleaning the air filter, make sure to attach it.
- Turn on the main power supply switch.
 - The control panel display lights when the power is turned on.
 - To protect the unit, turn on the main power switch at least 6 hours before operation.

What to do when stopping the system for a long period

- Turn on FAN OPERATION for a half day and dry the unit.
 - Refer to the manual of the remote controller.
- Cut off the power supply.
 - When the main power switch is turned on, some wattage is being consumed even if the system is not operating.
 - The remote controller display is turned off when the main power switch is turned off.

Disposal requirements

Dismantling of the unit, treatment of the refrigerant, oil and eventual other parts, should be done in accordance with the relevant local and national regulations.

ANNEX I

ONLY FOR AUSTRALIAN MODELS

NAME AND FUNCTION OF EACH SWITCH AND DISPLAY ON THE REMOTE CONTROLLER

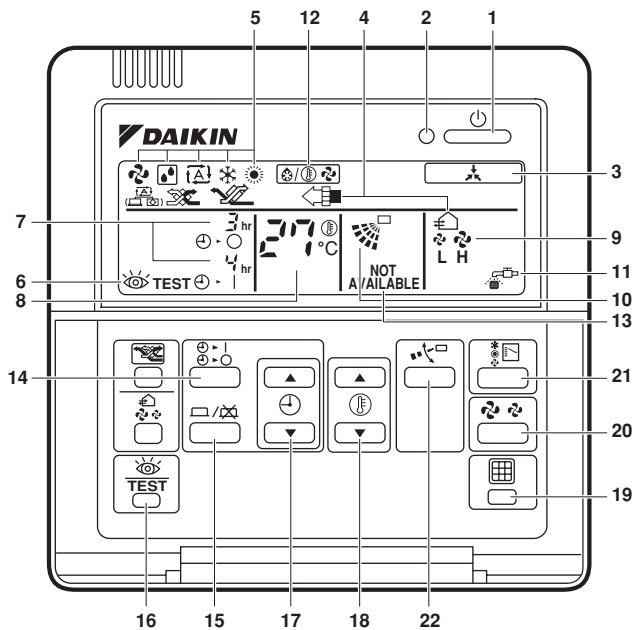

- 1 **ON/OFF BUTTON**
Press the button and the system will start.
Press the button again and the system will stop.
- 2 **OPERATION LAMP (RED)**
The lamp lights up during operation.
- 3 **DISPLAY " [Icon: Down Arrow] " (UNDER CENTRALIZED CONTROL)**
When this display shows, the system is UNDER CENTRALIZED CONTROL.
- 4 **DISPLAY " [Icon: House] " " [Icon: Fan] " " [Icon: Snowflake] " " [Icon: Sun] " (VENTILATION/AIR CLEANING)**
This display shows that the total heat exchange and the air cleaning unit are in operation (These are optional accessories).
- 5 **DISPLAY " [Icon: Fan] " " [Icon: Auto] " " [Icon: Snowflake] " " [Icon: Sun] " (OPERATION MODE)**
This display shows the current OPERATION MODE. For cooling only type, " [Icon: Auto] " (Auto) and " [Icon: Sun] " (Heating) are not installed.
- 6 **DISPLAY " [Icon: Eye] TEST " (INSPECTION/TEST OPERATION)**
When the INSPECTION/TEST OPERATION BUTTON is pressed, the display shows the system mode is in.
- 7 **DISPLAY " [Icon: Clock] " (PROGRAMMED TIME)**
This display shows the PROGRAMMED TIME of the system start or stop.
- 8 **DISPLAY " [Icon: Thermometer] " (SET TEMPERATURE)**
This display shows the set temperature.
- 9 **DISPLAY " [Icon: Fan] " (FAN SPEED)**
This display shows the set fan speed.
- 10 **DISPLAY " [Icon: Flap] " (AIR FLOW FLAP)**
Refer to "Air flow direction adjust" on page 7.

- 11 **DISPLAY " [Icon: Filter] " (TIME TO CLEAN AIR FILTER)**
Refer to "How to clean the air filter" on page 4.
- 12 **DISPLAY " [Icon: Defrost] " (DEFROST)**
Refer to "Defrost operation" on page 7.
- 13 **NON-FUNCTIONING DISPLAY**
If that particular function is not available, pressing the button may display the words "NOT AVAILABLE" for a few seconds.
When running multiple units simultaneously
The "NOT AVAILABLE" message will only appear if none of the indoor units is equipped with the function. If even one unit is equipped with the function, the display will not appear.
- 14 **TIMER MODE START/STOP BUTTON**
Refer to "Program timer operation" on page 8.
- 15 **TIMER ON/OFF BUTTON**
Refer to "Program timer operation" on page 8.
- 16 **INSPECTION/TEST OPERATION BUTTON**
This button is used only by qualified service persons for maintenance purposes.
- 17 **PROGRAMMING TIME BUTTON**
Use this button for programming "START and/or STOP" time.
- 18 **TEMPERATURE SETTING BUTTON**
Use this button for SETTING TEMPERATURE.
- 19 **FILTER SIGN RESET BUTTON**
Refer to "How to clean the air filter" on page 4.
- 20 **FAN SPEED CONTROL BUTTON**
Press this button to select the fan speed, HIGH or LOW, of your choice.
- 21 **OPERATION MODE SELECTOR BUTTON**
Press this button to select OPERATION MODE.
- 22 **AIR FLOW DIRECTION ADJUST BUTTON**
Refer to "Air flow direction adjust" on page 7.

NOTE For the sake of explanation, all indications are shown on the display in the figure contrary to actual running situations.

ANNEX II





ONLY FOR AUSTRALIAN MODELS

Cooling, heating, automatic, fan, and program dry operation

Operate in the following order.

1 Operation mode selector

Press OPERATION MODE SELECTOR button several times and select the OPERATION MODE of your choice as follows.

- COOLING OPERATION "  "
- HEATING OPERATION..... "  "
- AUTOMATIC OPERATION..... "  "
 - In this operation mode, COOL/HEAT changeover is automatically conducted.
- FAN OPERATION "  "
- DRY OPERATION..... "  "
 - The function of this program is to decrease the humidity in your room with the minimum temperature decrease.
 - Micro computer automatically determines TEMPERATURE and FAN SPEED.
 - This system does not go into operation if the room temperature is below 16°C.

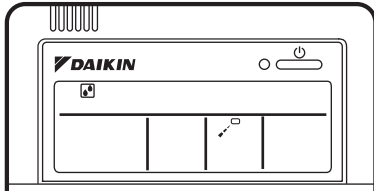

- For cooling only type, "COOLING", "FAN" and "DRY" operation are able to select.

2 ON/OFF

Press ON/OFF BUTTON.

OPERATION lamp lights up or goes off and the system starts or stops OPERATION.

[Explanation of heating operation]

Defrost operation

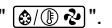
- As the frost on the coil of an outdoor unit increase, heating effect decreases and the system goes into DEFROST OPERATION.
- The indoor unit fan stops and the remote controller display shows "  ".
- After 6 to 8 minutes (maximum 10 minutes) of DEFROST OPERATION, the system returns to HEATING OPERATION.

Regarding outside air temperature and heating capacity

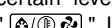
- The heating capacity of the air conditioner declines as the outside air temperature falls. In such a case, use the air conditioner in combination with other heating systems.
- A warm air circulating system is employed, and therefore it takes some time until the entire room is warmed up after the start of operation.
- An indoor fan runs to discharge a gentle wind automatically until the temperature inside the air conditioner reaches a certain level. At this time, the remote controller displays "  ". Leave it as it stands and wait for a while.
- When the warm air stays under the ceiling and your feet are cold, we recommend that you use a circulator (a fan to circulate the air inside the room). For details, consult your dealer.

Adjustment

For programming TEMPERATURE, FAN SPEED and AIR FLOW DIRECTION, follow the procedure shown below.

Temperature setting

Press TEMPERATURE SETTING button and program the setting temperature.

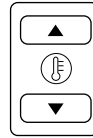

Each time this button is pressed, setting temperature rises 1°C.

Each time this button is pressed, setting temperature lowers 1°C.

The setting is impossible for fan operation.

Fan speed control

Press FAN SPEED CONTROL button.

High or Low fan speed can be selected.

The micro computer may sometimes control the fan speed in order to protect the unit.

Air flow direction adjust

Press the AIR FLOW DIRECTION ADJUST button to adjust the air flow angle.

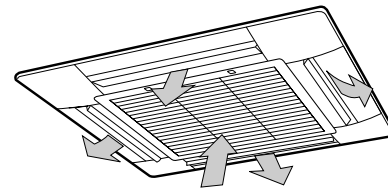

Up and down adjustment

The movable limit of the flap is changeable. Contact your dealer for details.

Press the air flow direction adjust button to select the air direction as follows.



The AIR FLOW FLAP display swings as shown the left and the air flow direction continuously varies. (Automatic swing setting)



Press AIR FLOW DIRECTION ADJUST button to select the air direction of your choice.



The AIR FLOW FLAP display stops swinging and the air flow direction is fixed (Fixed air flow direction setting).

Movement of the air flow flap

For the following conditions, micro computer controls the air flow direction so it may be different from the display.

Operation mode	Cooling	Heating
Operation condition	When room temperature is lower than the set temperature	When room temperature is higher than the set temperature At defrost operation
	When operating continuously at downward air flow direction	

Operation mode includes automatic operation.

Operate in the following order.

- The timer is operated in the following two ways.
- Programming the stop time (⊕ ▶ ○)
.... The system stops operating after the set time has elapsed.
- Programming the start time (⊕ ▶ |)
.... The system starts operating after the set time has elapsed.
- The timer can be programmed a maximum of 72 hours.
- The start and the stop time can be simultaneously programmed.

1 TIMER MODE START/STOP ⊕▶○

Press the TIMER MODE START/STOP button several times and select the mode on the display.
The display flashes.

For setting the timer stop "⊕ ▶ ○"

For setting the timer start "⊕ ▶ |"

2 PROGRAMMING TIME ⊕

Press the PROGRAMMING TIME button and set the time for stopping or starting the system.

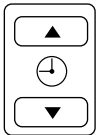

When this button is pressed, the time advances by 1 hour.

When this button is pressed, the time goes backward by 1 hour.

3 TIMER ON/OFF □/⊗

Press the TIMER ON/OFF BUTTON.
The timer setting procedure ends.

The display "⊕ ▶ ○" or "⊕ ▶ |" changes from flashing light to a constant light.

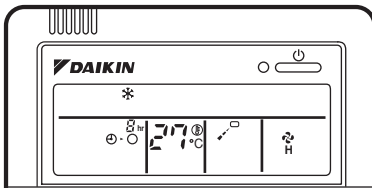

NOTE



When setting the timer Off and On at the same time, repeat the above procedure from 1 to 3 once again.

When the timer is programmed to stop the system after 3 hours and start the system after 4 hours, the system will stop after 3 hours and then 1 hour later the system will start.

- After the timer is programmed, the display shows the remaining time.
- Press the TIMER ON/OFF BUTTON once again to cancel programming. The display vanishes.

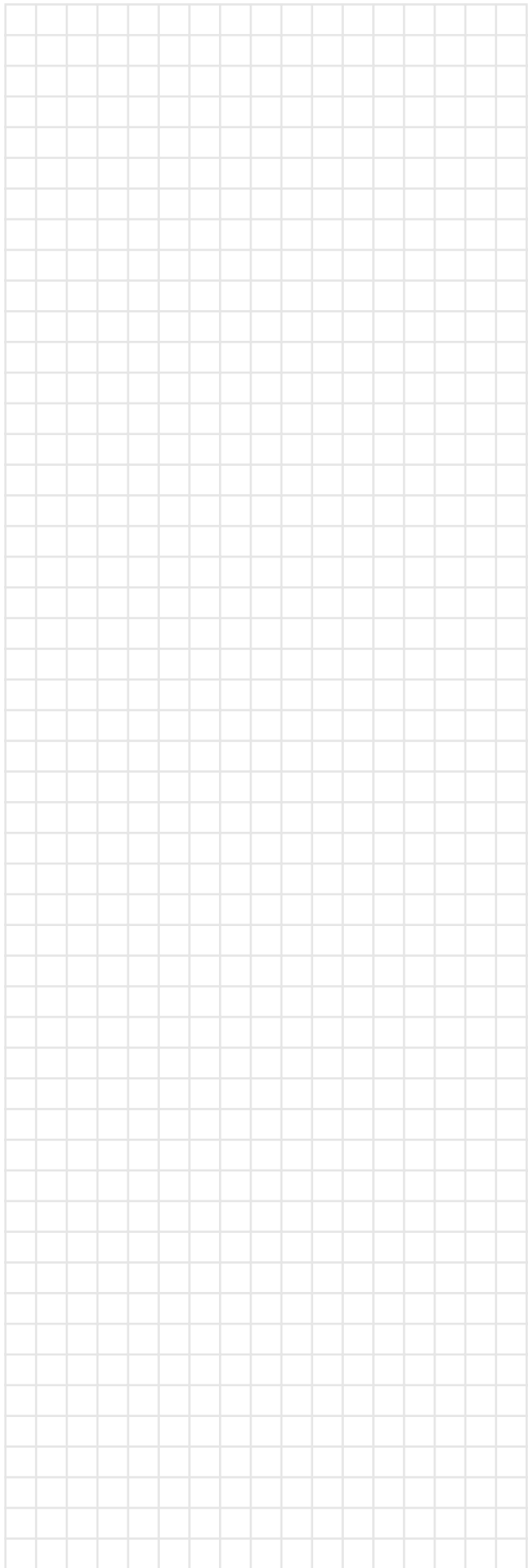

NOTES

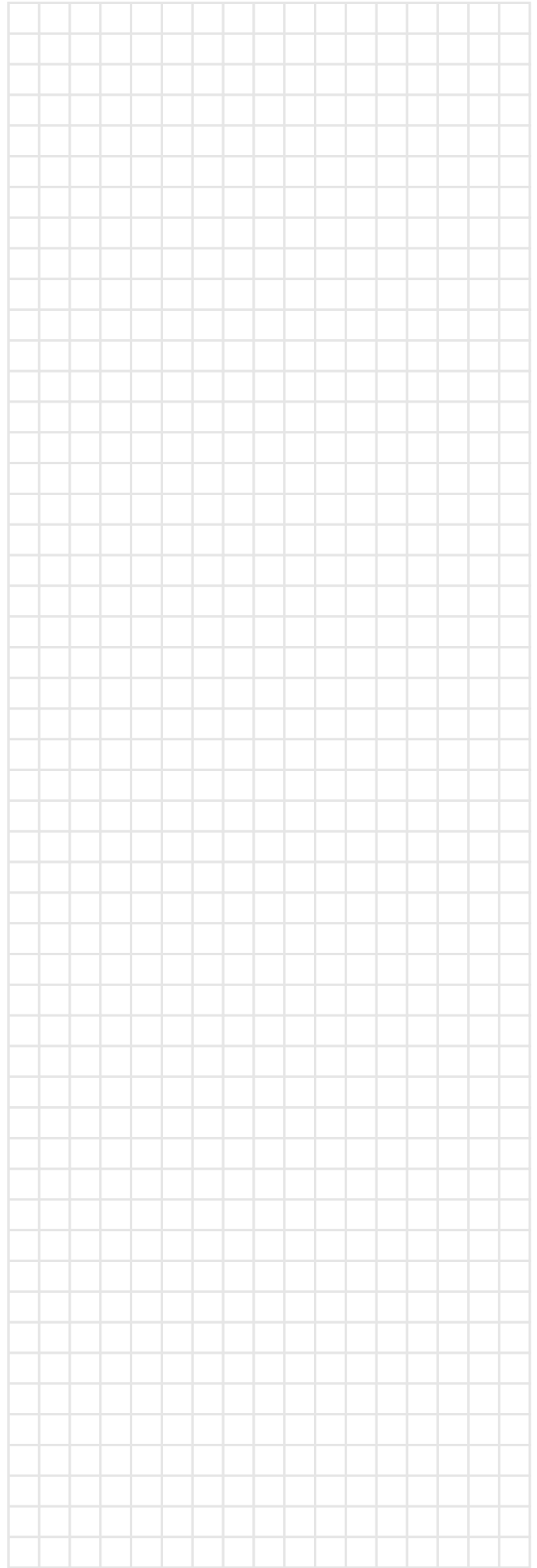
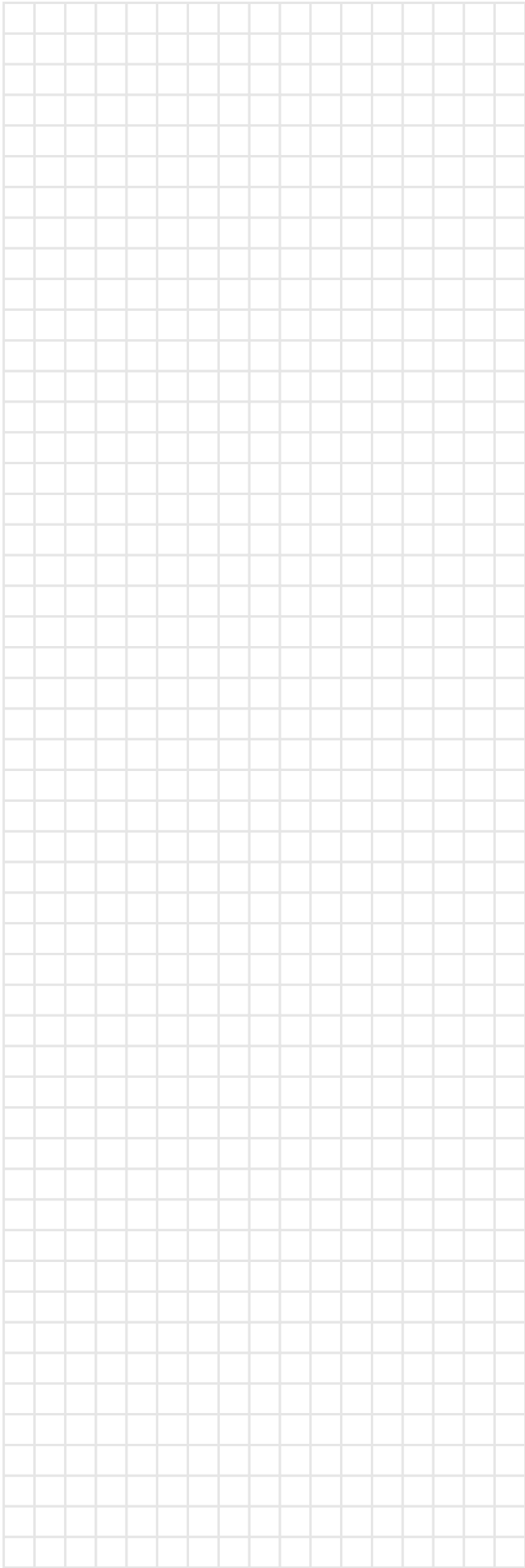

DAIKIN EUROPE NV

Zandvoordestraat 300, B-8400 Oostende, Belgium

4PWEN18600-1