

**DAIKIN**



# OPERATION MANUAL

## Split system air conditioners

FFQ25B9V1B  
FFQ35B9V1B  
FFQ50B9V1B  
FFQ60B9V1B

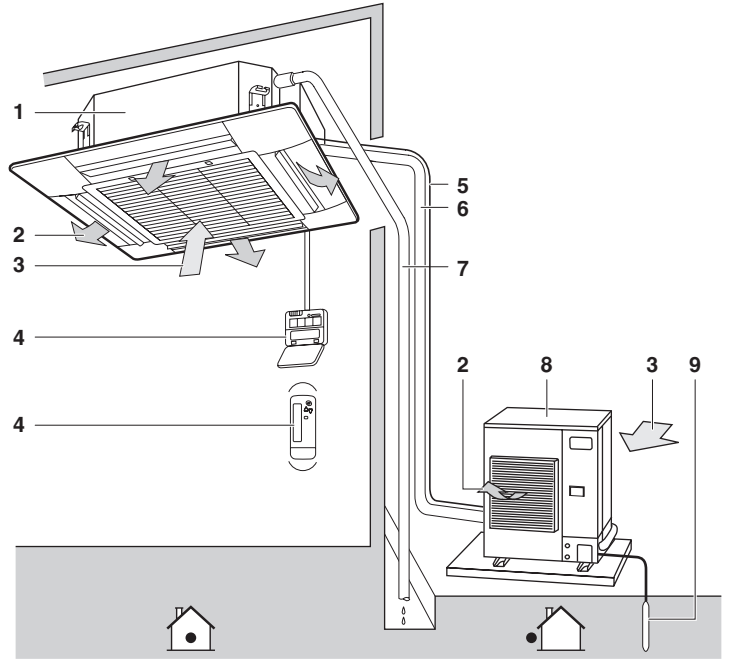
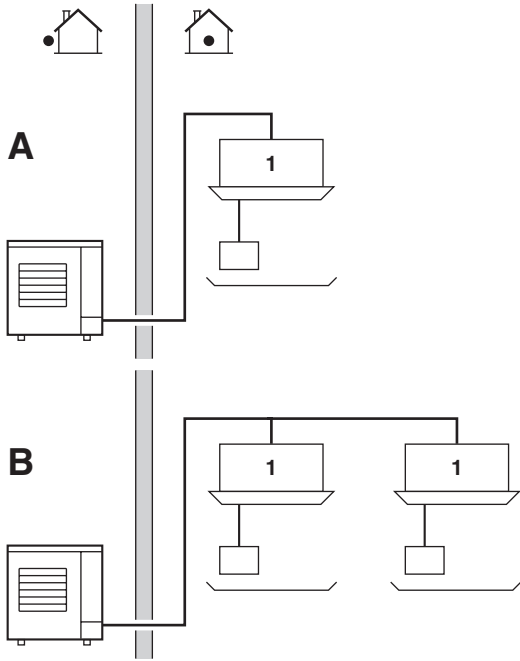

1

2

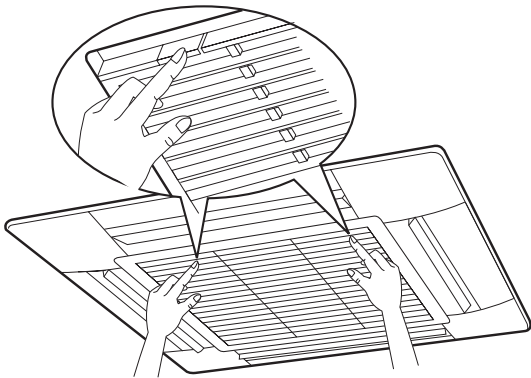

3

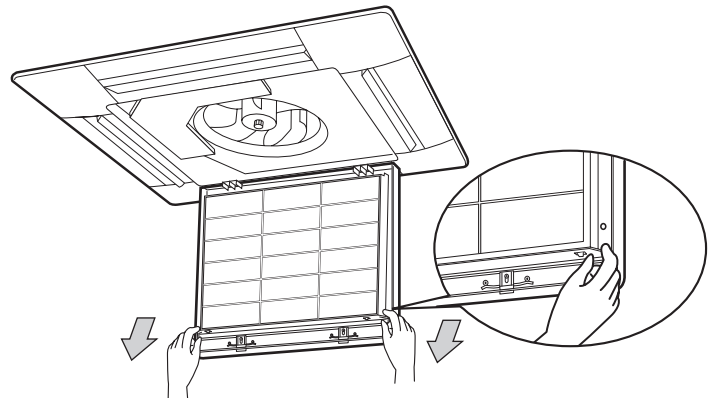

4

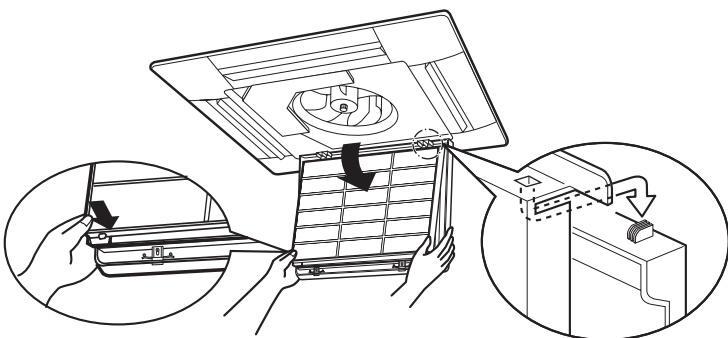

5

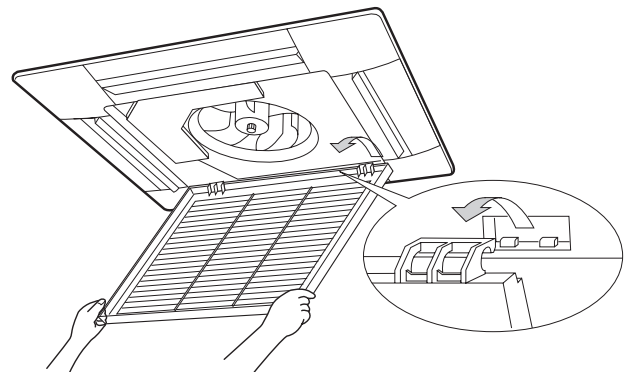

6

## CONTENTS

	Page
What to do before operation .....	1
Important information regarding the refrigerant used .....	1
Safety considerations .....	1
Names and functions of parts.....	1
Operation range.....	2
Installation site.....	2
Name and function of each switch and display on the remote controller.....	2
Operation procedure.....	2
Optimum operation .....	2
Not a malfunction of the air conditioner .....	3
Troubleshooting .....	4
Maintenance .....	4

The original instructions are written in English. All other languages are translations of the original instructions.



THANK YOU FOR PURCHASING THIS DAIKIN AIR CONDITIONER. CAREFULLY READ THIS OPERATION MANUAL BEFORE USING THE AIR CONDITIONER. IT WILL TELL YOU HOW TO USE THE UNIT PROPERLY AND HELP YOU IF ANY TROUBLE OCCURS. AFTER READING THE MANUAL, FILE IT AWAY FOR FUTURE REFERENCE.

## WHAT TO DO BEFORE OPERATION (See figure 1)

This operation manual is for the following systems with standard control. Before initiating operation, contact your Daikin dealer for the operation manual that corresponds to your system.

### NOTE



These units can be controlled by a remote controller. Refer to the manual of the remote controller for more information.

If your installation has a customized control system, ask your Daikin dealer for the operation that corresponds to your system.

- A Pair system
- B Multi system
- 1 Unit with remote controller

- Heat pump type  
This system provides cooling, heating, automatic, and fan operation modes.
- Straight cooling type  
This system provides cooling, and fan operation modes.

## IMPORTANT INFORMATION REGARDING THE REFRIGERANT USED

This product contains fluorinated greenhouse gases covered by the Kyoto Protocol.

Refrigerant type: R410A  
 GWP<sup>(1)</sup> value: 1975

<sup>(1)</sup> GWP = global warming potential

Periodical inspections for refrigerant leaks may be required depending on European or local legislation. Please contact your local dealer for more information.

## SAFETY CONSIDERATIONS



- Never let the indoor unit and the remote controller get wet.  
It may cause an electric shock or a fire.
- Never use flammable spray such as hair spray, lacquer or paint near the unit.  
It may cause a fire.
- Never replace a fuse with that of a wrong ampere rating or other wires when the fuse blows out.  
Use of wire or copper wire may cause the unit to break down or cause a fire.
- This appliance is not intended for use by persons, including children, with reduced physical, sensory or mental capabilities, or lack of experience and knowledge, unless they have been given supervision or instruction concerning use of the appliance by a person responsible for their safety.  
Children should be supervised to ensure that they do not play with the appliance.
- Never touch the air outlet or the horizontal blades while the swing flap is in operation.  
Fingers may become caught or the unit may break down.
- Never insert objects such as sticks into the air inlet or outlet. It is dangerous for an object to touch the fan when it is turning at high speed.
- Never remove the fan guard of the outdoor unit.  
The rotating fan at high speed without the guard is very dangerous.
- Never inspect or service the unit by yourself.  
Ask a qualified service person to perform this work.





## NAMES AND FUNCTIONS OF PARTS (See figure 2)



- 1 Indoor unit
- 2 Discharged air
- 3 Inlet air
- 4 Remote controller
- 5 Connection electric wire
- 6 Refrigerant piping
- 7 Drain pipe
- 8 Outdoor unit
- 9 Ground wire  
Wire to ground outdoor unit to prevent electrical shocks.





## OPERATION RANGE

If operating outside the following conditions, safety devices may activate, rendering the air conditioner inoperable or may cause the indoor unit to sweat.

The setting temperature range of the remote controller is 16°C~32°C.

				
	°C			
RS50-60 RKS25-35-50-60 RXS25-35-50-60	°C DB °C WB	21~32 14~23	≤80%	-10~46 <sup>(*)</sup>
3MKS50 4MKS58-75-90 3MXS52 4MXS68-80	°C DB °C WB	21~32 14~23	≤80%	-10~46
RZQ(G)71-100-125-140	°C DB °C WB	18~35 12~28	≤80%	-15~50
RZQS(G)71-100-125-140	°C DB °C WB	18~35 14~28	≤80%	-5~46

				
	°C		°C	
RXS25-35	°C DB	10~30	°C DB °C WB	-10~24 -15~20
RXS50-60	°C DB	10~30	°C DB °C WB	-14~24 -15~18
3MXS52 4MXS68-80	°C DB	10~30	°C DB °C WB	-10~21 -15~15.5
RZQ(G)71-100-125-140	°C DB	10~27	°C DB °C WB	-13~21 -20~15.5
RZQS(G)71-100-125-140	°C DB	10~27	°C DB °C WB	-9~21 -10~15.5

(DB=dry bulb, WB=wet bulb, =cooling, =heating, =indoor, =outdoor, °C=temperature, =humidity)

(\*) For Australian models: -5~46°C

## INSTALLATION SITE

-  Never place anything under the indoor unit that you don't want to get wet. The unit may sweat when the humidity is over 80% or when the drain outlet is clogged.
  - Never place other heating equipment directly beneath the indoor unit. Subject to deformation caused by heat.
  - Do not place TV, radio, stereo, etc. within 1 meter from the indoor unit and remote controller. Doing so may cause interference in the picture or sound.
- 
- Do not place objects in direct proximity of the outdoor unit and do not let leaves and other debris accumulate around the unit. Leaves are a hotbed for small animals which can enter the unit. Once in the unit, such animals can cause malfunctions, smoke or fire when making contact with electrical parts.

## NAME AND FUNCTION OF EACH SWITCH AND DISPLAY ON THE REMOTE CONTROLLER

-  Refer to the operation manual delivered with the remote controller.

## OPERATION PROCEDURE



- If a function that is not available is selected, the message NOT AVAILABLE will appear.
- Operating procedure varies with heat pump type and straight cooling type. Contact your Daikin dealer to confirm your system type.
- To protect the unit, turn on the main power switch 6 hours before operation.
- If the main power supply is turned off during operation, operation will restart automatically after the power turns back on again.

### NOTE



Set the temperature within the ranges mentioned under "Operation range" on page 2.

## Precautions for group control system or two remote controller control system

This system provides two other control systems beside individual control (one remote controller controls one indoor unit) system. Confirm the following if your unit is of the following control system type.

- Group control system  
One remote controller controls up to 16 indoor units. All indoor units are equally set.
- Two remote controller control system  
Two remote controllers control one indoor unit (In case of group control system, one group of indoor units). The unit is individually operated.

### NOTE



Contact your Daikin dealer in case of changing the combination or setting of group control and two remote controller control systems.

## OPTIMUM OPERATION



Observe the following precautions to ensure the system operates properly.

- Adjust the air outlet properly and avoid direct air flow to room inhabitants.
- Adjust the room temperature properly for a comfortable environment. Avoid excessive heating or cooling.
- Prevent direct sunlight from entering a room during cooling operation by using curtains or blinds.
- Keep doors and windows closed. If the doors and windows remain open, room air will flow out and decrease the effect of cooling and heating.
- Never place objects near the air inlet and the air outlet of the unit. It may retard effectiveness or cause operation to stop.
- Turn off the main power supply switch when not using for long periods of time. Electricity is consumed as long as the switch is on. Turn off the main power supply switch in order to save energy. Turn on the main power supply switch 6 hours before restarting operation in order to ensure smooth operation. (Refer to "Maintenance" on page 4.)
- When the display shows  (TIME TO CLEAN AIR FILTER), have a qualified service person to clean the filters. (Refer to "Maintenance" on page 4.)

## NOT A MALFUNCTION OF THE AIR CONDITIONER

The following symptoms do not indicate air conditioner malfunction.

### The system does not operate

- The system does not restart immediately after the ON/OFF button is pressed.  
If the OPERATION lamp lights, the system is in its normal operating condition.  
It does not restart immediately because one of its safety devices actuates to prevent the system from being overloaded.  
The system will turn on again automatically after three minutes.
- The system does not restart immediately when the TEMPERATURE SETTING button is returned to its former position after pushing.  
It does not restart immediately because one of its safety devices actuates to prevent the system from being overloaded.  
The system will turn on again automatically after three minutes.
- The system does not start when the display shows ""  
(EXTERNAL CONTROL ICON) and it flashes for a few seconds after pressing an operation button.  
This is because the system is controlled or disabled by another controller with a higher priority.  
When the display flashes, it indicates that the system cannot be controlled by this indoor unit.
- The system does not start immediately after the power supply is turned on.  
Wait one minute until the micro computer is prepared for operation.
- The outdoor unit has stopped.  
This is because the room temperature has reached the set temperature. The unit switches to fan operation.  
" (EXTERNAL CONTROL ICON) is displayed on the remote controller and the actual operation is different from the remote controller setting.  
For multi split models, the micro computer executes the following control depending on the operation mode of other indoor units.
  - Before you start to operate, the other indoor unit(s) is (are) already operating. When the operation mode of this unit is different from your choice, the indoor unit of your room may be put in waiting condition. (Fan: Stop, Horizontal flap: Horizontal position)

Your room	Operation mode			
	Cooling	Dry	Fan only	Heating
Cooling	O	O	O	W
Dry	O	O	O	W
Fan only	O	O	O	W
Heating	W	W	W	O

O: your unit can operate  
W: your unit in waiting mode

- When the total cooling capacity of all indoor units which are operating is beyond the capacity limit of the outdoor unit, your indoor unit will be put in waiting condition. (Fan and horizontal flap: Same as setting: (cooling only model only))
- After cooling mode operation of the unit of your room, when other unit(s) start to operate, the unit of your room may operate as follows: Fan: L tab, Horizontal flap: Horizontal position.
- The fan speed is different from the setting. Pressing the fan speed control button does not change the fan speed.  
When the room temperature reaches the set temperature in heating mode, the capacity supply from the outdoor unit has stopped and the indoor unit operates in fan only mode (L tab). In case of multi split, the indoor unit alternately operates fan stop and fan only mode (L tab).  
This is to prevent the cool air from being blown directly onto anyone present in the room.

### Air blow direction is not as specified

- Actual air blow direction is not as shown on the remote controller.
- Automatic swing setting does not work.  
Refer to the manual of the remote controller.

### White mist comes out of a unit

- When humidity is high during cooling operation (In oily or dusty places).  
If the inside of an indoor unit is extremely contaminated, the temperature distribution inside a room becomes uneven. It is necessary to clean the inside of the indoor unit. Ask your Daikin dealer for details on cleaning the unit. This operation requires a qualified service person.
- When the system is changed over to HEATING OPERATION after DEFROST OPERATION.  
Moisture generated by DEFROST becomes steam and exits.

### Noise of air conditioners

- A ringing sound is heard after the unit is started. This sound is generated by the temperature regulator operation. It will quiet down after about a minute.
- A continuous low "hissing" sound is heard when the system is in COOLING or DEFROST OPERATION.  
This is the sound of refrigerant gas flowing through both indoor and outdoor units.
- A "hissing" sound which is heard at the start or immediately after the stop of operation or which is heard at the start or immediately after the stop of DEFROST OPERATION.  
This is the noise of refrigerant caused by flow stop and flow change.
- A continuous low "swishing" sound is heard when the system is in COOLING OPERATION or at a stop.  
The noise is heard when the drain pump is in operation.
- A "squeaking" sound is heard when the system is in operation or after the stop of operation.  
Expansion and contraction of plastic parts caused by temperature change makes this noise.

### Dust from the units

- Dust may blow out from the unit after starting operation from long resting time. Dust absorbed by the unit blows out.

### The units give off odours

- The unit absorbs the smell of rooms, furniture, cigarettes, etc., and then emits them.

### The liquid crystal display of the remote controller shows "88"

- Happens immediately after the main power supply switch is turned on.  
Shows that the remote controller is in normal condition.  
Continues temporarily.

## TROUBLESHOOTING

If one of the following malfunctions occurs, take the measures shown below and contact your Daikin dealer.

The system must be repaired by a qualified service person.

- If a safety device such as a fuse, a breaker, or an earth leakage breaker frequently actuates, or ON/OFF switch does not properly work.  
Measure: Turn off the main power switch.
- If water leaks from unit.  
Measure: Stop the operation.
- If the display "🔍" (INSPECTION), "UNIT No.", and the OPERATION lamp flashes and the "MALFUNCTION CODE" appears.  
Measure: Notify your Daikin dealer and inform him/her of the display.

If the system does not operate properly, except for the above mentioned case, and none of the above mentioned malfunctions are evident, investigate the system according to the following procedures.

### ***If the system does not operate at all.***

- Check if there is a power failure.  
Wait until power is restored. If power failure occurs during operation, the system automatically restarts immediately after the power supply recovers.
- Check if the fuse has blown or breaker has been tripped.  
Change the fuse or set the breaker.

### ***If the system stops operating after operation is complete.***

- Check if the air inlet or outlet of outdoor or indoor unit is blocked by obstacles.  
Remove the obstacle and make it well-ventilated.
- Check if the air filter is clogged.  
Ask a qualified service person to clean the air filter.

### ***The system operates but it does not sufficiently cool or heat.***

- If the air inlet or outlet of the indoor or the outdoor unit is blocked with obstacles.  
Remove the obstacle and make it well-ventilated.
- If the air filter is clogged.  
Ask a qualified service person to clean the air filter.
- If the set temperature is not proper. (Refer to the manual of the remote controller)
- If the FAN SPEED CONTROL button is set to LOW SPEED. (Refer to the manual of the remote controller)
- If the air flow angle is not proper. (Refer to the manual of the remote controller)
- If the doors or the windows are open. Shut doors or windows to prevent wind from coming in.
- If direct sunlight enters the room (when cooling).  
Use curtains or blinds.
- When there are too many inhabitants in the room. Cooling effect decreases if heat gain of the room is too large.
- If the heat source of the room is excessive (when cooling).  
Cooling effect decreases if heat gain of the room is too large.

## MAINTENANCE

### IMPORTANT

- ONLY A QUALIFIED SERVICE PERSON IS ALLOWED TO PERFORM MAINTENANCE.
- BEFORE OBTAINING ACCESS TO TERMINAL DEVICES, ALL POWER SUPPLY CIRCUITS MUST BE INTERRUPTED.
- DO NOT USE WATER OR AIR OF 50°C OR HIGHER FOR CLEANING AIR FILTERS AND OUTSIDE PANELS.
- WHEN CLEANING THE HEAT EXCHANGER, BE SURE TO REMOVE THE SWITCHBOX, FAN MOTOR AND DRAIN PUMP. WATER OR DETERGENT MAY DETERIORATE THE INSULATION OF ELECTRIC COMPONENTS AND RESULT IN BURN-OUT OF THESE COMPONENTS.

See figure 2

- 1 Indoor unit
- 2 Discharged air
- 3 Inlet air
- 4 Remote controller
- 5 Connection electric wire
- 6 Refrigerant piping
- 7 Drain pipe
- 8 Outdoor unit
- 9 Ground wire  
Wire to ground outdoor unit to prevent electrical shocks.

### How to clean the air filter

Clean the air filter when the display shows "🔍" (TIME TO CLEAN AIR FILTER).

Increase the frequency of cleaning if the unit is installed in a room where the air is extremely contaminated.

(As a yardstick for yourself, consider cleaning the filter once a half year.)

If dirt becomes impossible to clean, change the air filter. (Air filter for exchange is optional.)

1. Open the suction grill  
Push both knobs simultaneously and carefully lower the grille. (Identical procedure for closing.) (See figure 3)
2. Remove the air filters  
Pull the hook of the air filter out diagonally downward and remove the filter. (See figure 4)
3. Clean the air filter  
Use a vacuum cleaner or wash the air filter with water. When the air filter is very dirty, use a soft brush and neutral detergent.

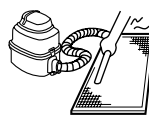

Remove water and dry in the shade.

4. Fix the air filter  
Attach the air filter to the suction grill by hanging it to the projected portion above the suction grill.  
Press the bottom of the air filter against the projections on the bottom of the grille to snap the air filter into its place. (See figure 5)
5. Shut the air inlet grill  
Refer to item No. 1.
6. After turning power on, press the FILTER SIGN RESET button  
The "TIME TO CLEAN AIR FILTER" display disappears.  
(For details, refer to the operation manual of the outdoor unit.)

**NOTE** Do not remove the air filter except when cleaning. Unnecessary handling may damage the filter.

## How to clean the air outlet and outside panels

- Clean with a soft cloth.
- When it is difficult to remove stains, use water or neutral detergent.
- When the blade is extremely contaminated, remove it as below and clean it.

### NOTE



- Do not use gasoline, benzene, thinner, polishing powder nor liquid insecticide. It may cause discolouring or warping.
- Do not let the indoor unit get wet. It may cause electric shock or fire.

## How to clean the suction grill

1. Open the suction grill  
Push both knobs simultaneously and carefully lower the grille. (Identical procedure for closing.) (See figure 3)
2. Detach the suction grill  
Open the suction grill 45 degrees and lift it upward. (See figure 6)
3. Detach the air filter  
See the figure in item No. 2 in chapter "How to clean the air filter" on page 4.
4. Clean the suction grill  
Wash it with a soft brush and neutral detergent, and dry thoroughly.



### NOTE



When the suction grill is very dirty, use a typical kitchen cleaner and let it sit for about 10 minutes. Then, wash it with water.

5. Fix the air filter  
See the figure in item No. 4 in chapter "How to clean the air filter" on page 4.
6. Re-attach the suction grill  
See item No. 2.
7. Close the suction grill  
See item No. 1.

## Start-up after a long stop

- Confirm the following.
  - Check that the air inlet and outlet are not blocked. Remove any obstacle.
  - Check if the earth is connected.
- Clean the air filter and outside panels.
  - After cleaning the air filter, make sure to attach it.
- Turn on the main power supply switch.
  - The control panel display lights when the power is turned on.
  - To protect the unit, turn on the main power switch at least 6 hours before operation.

## What to do when stopping the system for a long period

- Turn on FAN OPERATION for a half day and dry the unit.
  - Refer to the manual of the remote controller.
- Cut off the power supply.
  - When the main power switch is turned on, some wattage is being consumed even if the system is not operating.
  - The remote controller display is turned off when the main power switch is turned off.

## Disposal requirements

Dismantling of the unit, treatment of the refrigerant, of oil and of other parts must be done in accordance with relevant local and national legislation.



Your air conditioning product is marked with this symbol. This means that electrical and electronic products shall not be mixed with unsorted household waste.

Do not try to dismantle the system yourself: the dismantling of the air conditioning system, treatment of the refrigerant, of oil and of other parts must be done by a qualified installer in accordance with relevant local and national legislation.

Air conditioners must be treated at a specialized treatment facility for re-use, recycling and recovery. By ensuring this product is disposed of correctly, you will help to prevent potential negative consequences for the environment and human health. Please contact the installer or local authority for more information.

Batteries must be removed from the remote controller and disposed of separately in accordance with relevant local and national legislation.

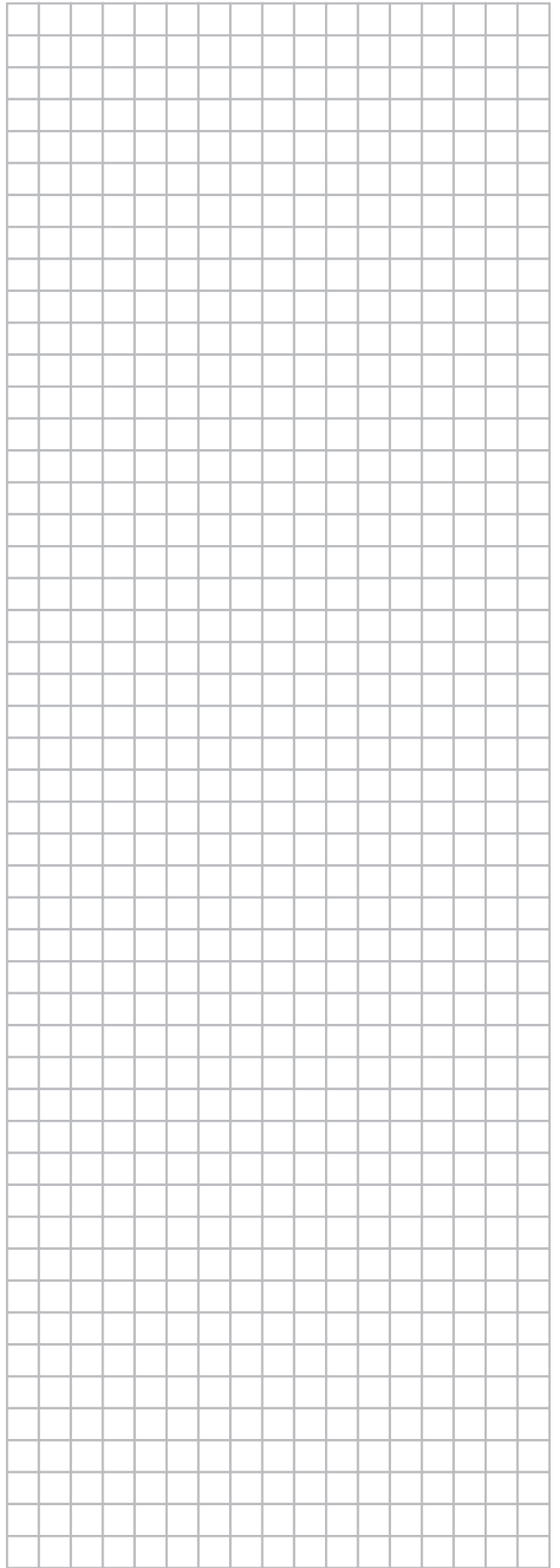
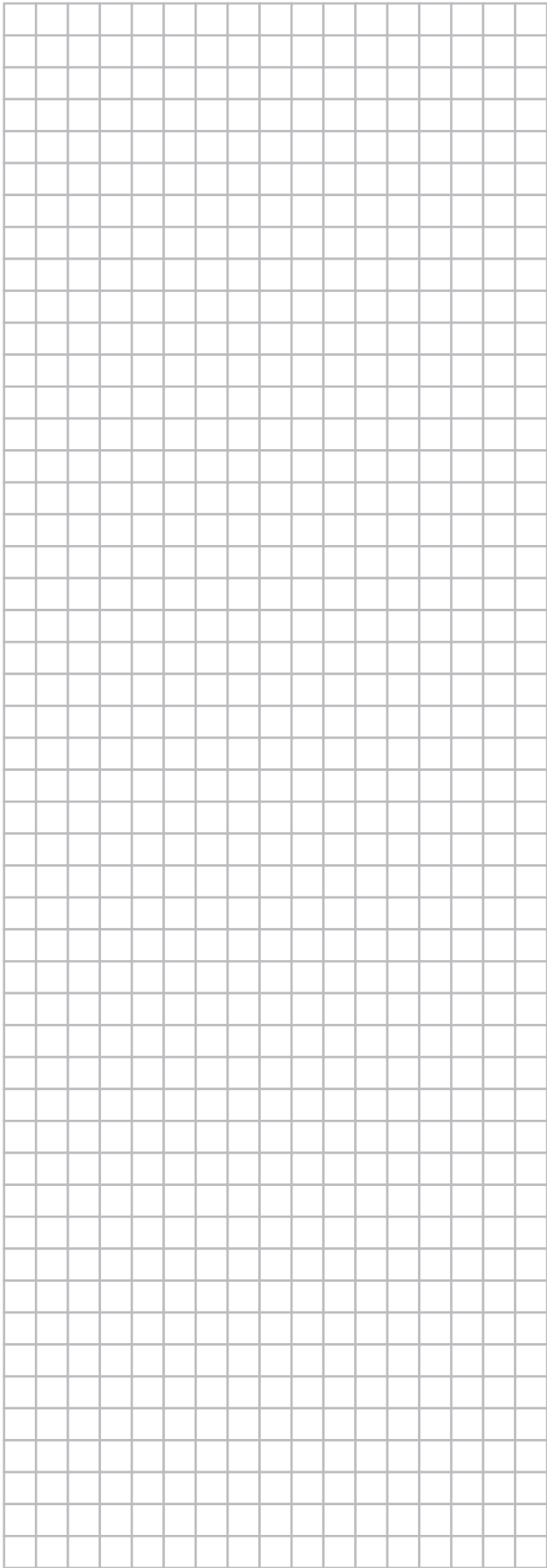



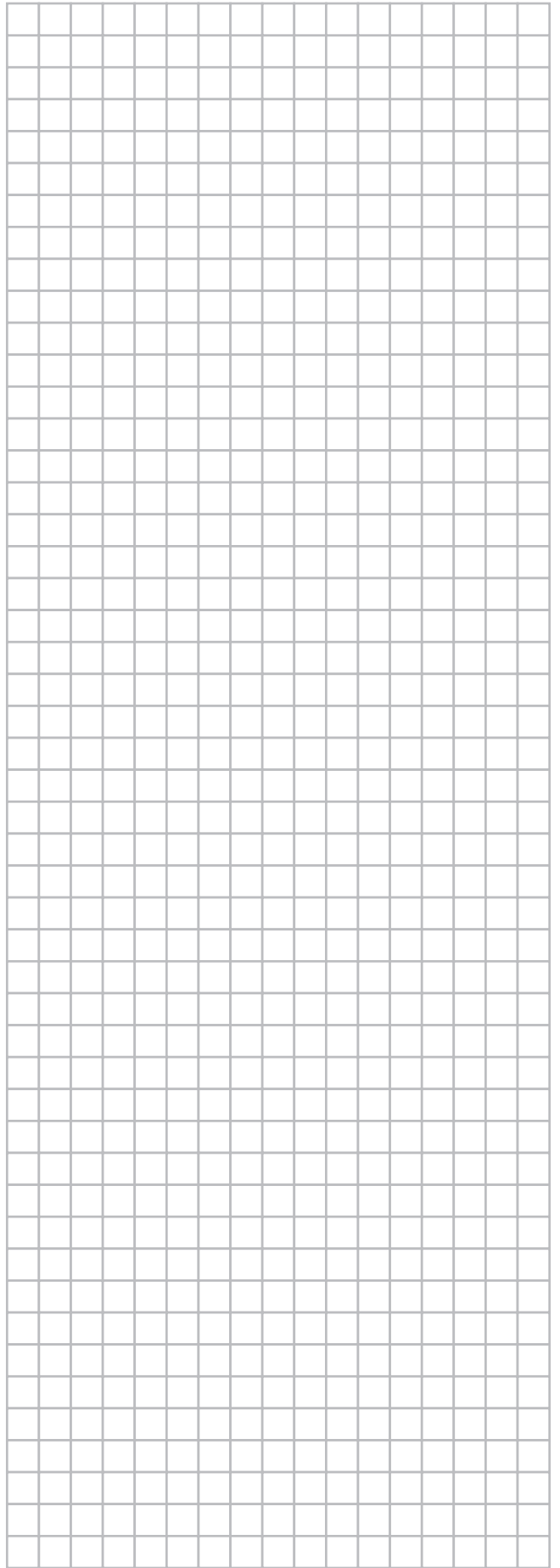
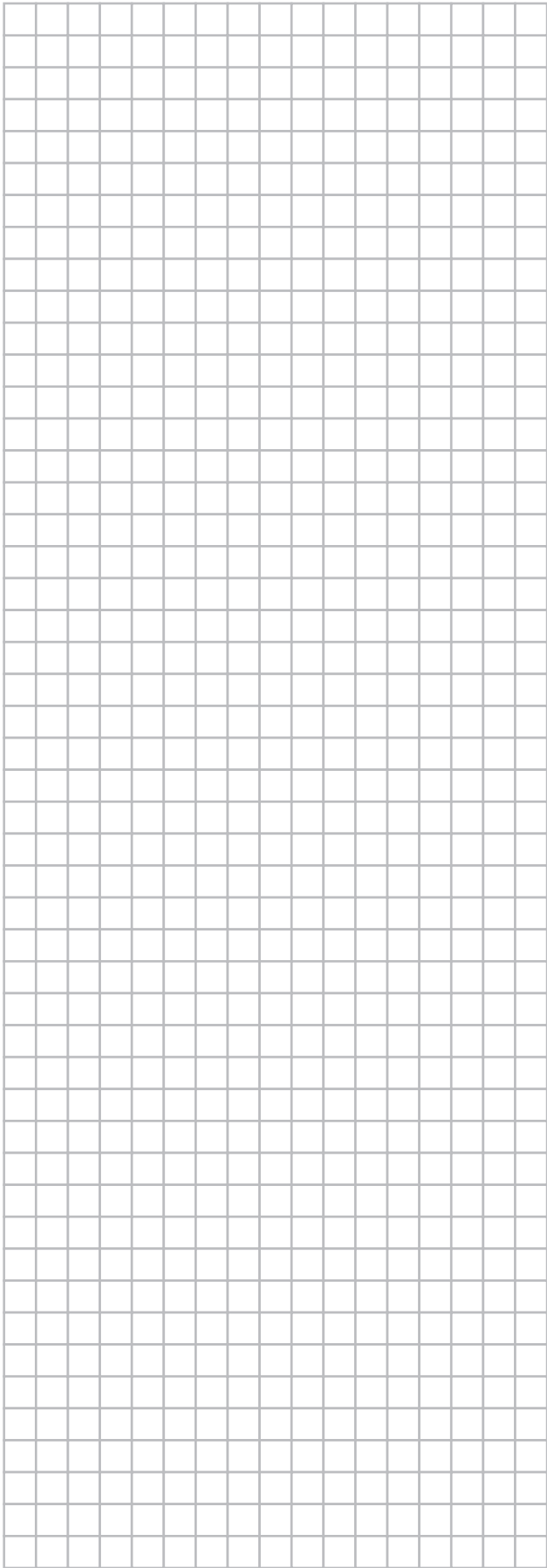

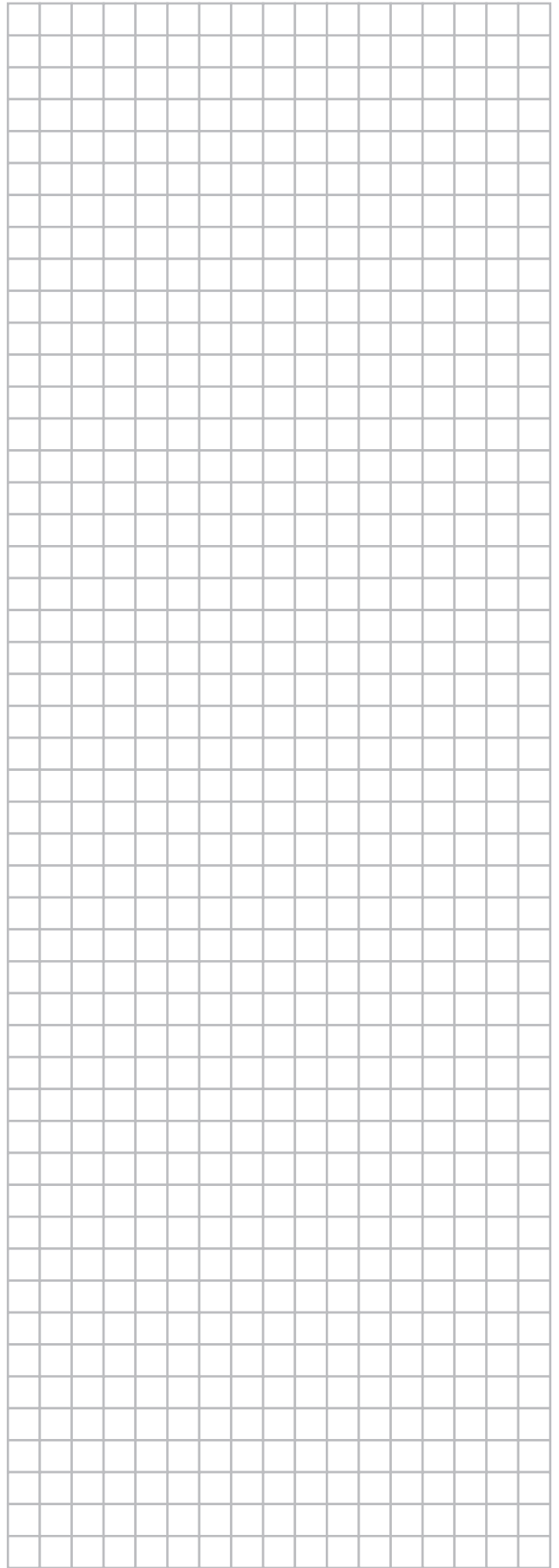
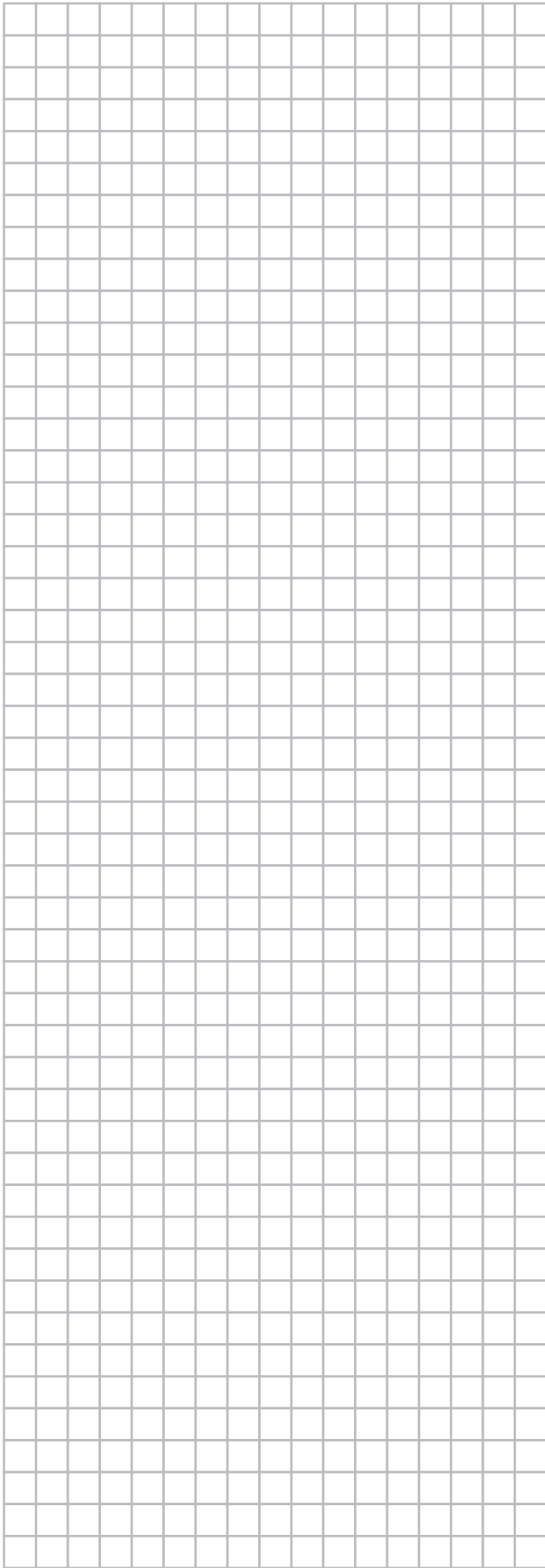

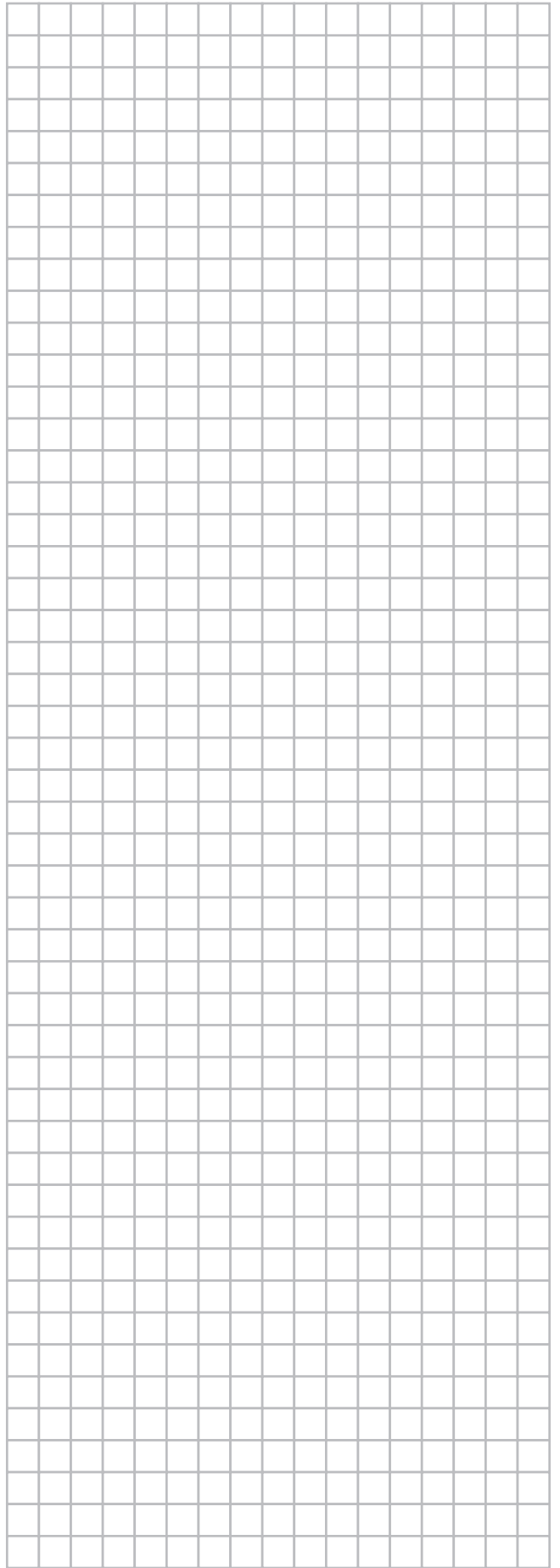
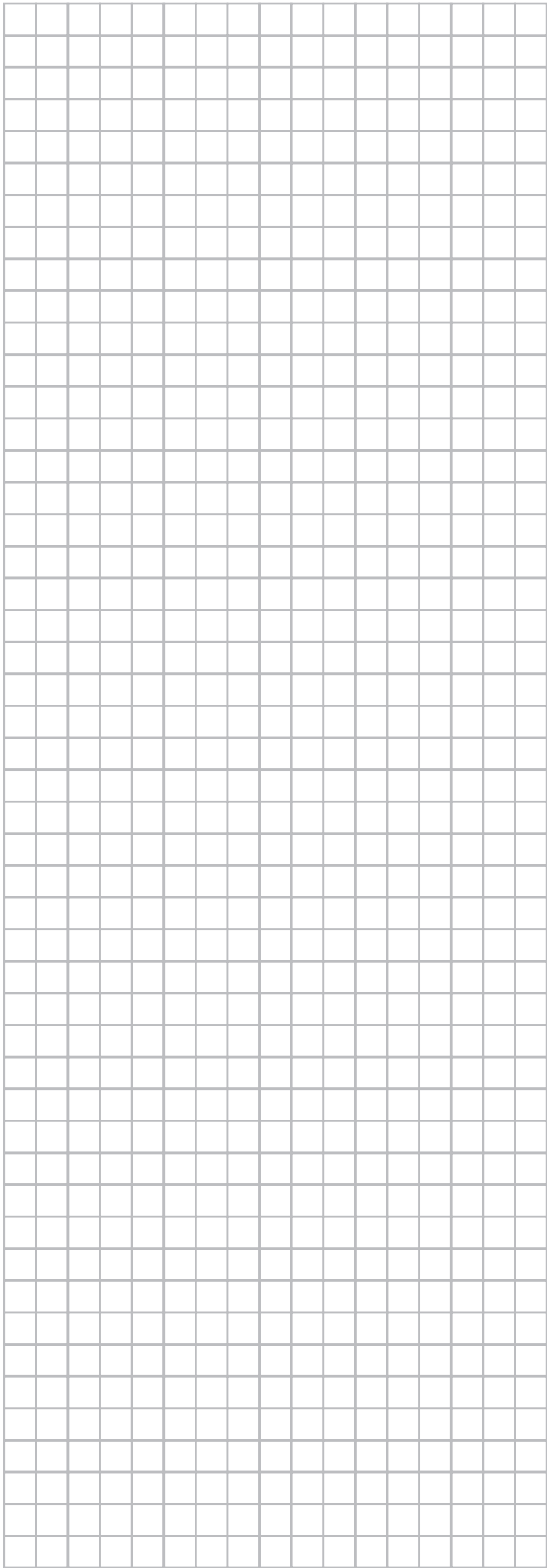



\*4PW70943-1 000000A\*

Copyright 2011 Daikin

**DAIKIN EUROPE N.V.**

Zandvoordestraat 300, B-8400 Oostende, Belgium

4PW70943-1 08.2011