

---

**SPLIT SYSTEM****Air Conditioner**

English

Deutsch

Français

Español

Italiano

Ελληνικά

Nederlands

Portugues

Русский

MODELS  
(Wall mounted type)

**FAQ100BUV1B**  
**FAQ100BVV1B**

Thank you for purchasing this Daikin air conditioner. Carefully read this operation manual before using the air conditioner. It will tell you how to use the unit properly and help you if any trouble occurs. After reading the manual, file it away for future reference. Operation: see the remote controller operation manual for details on the names and functions of switches and displays on the remote controller.

Vielen Dank für den Kauf einer Klimaanlage von Daikin. Bitte lesen Sie diese Bedienungsanleitung vor der Inbetriebnahme des Gerätes gründlich durch. Hier wird erklärt, wie das Gerät richtig eingesetzt wird und was bei Störungen zu tun ist. In dieser Anleitung wird nur das Innenaggregat beschrieben. Verwenden Sie diese Anleitung zusammen mit der Bedienungsanleitung des Außenaggregats. Nach dem Lesen der Anleitung legen Sie diese griffbereit zum Nachschlagen auf. Bedienung: In der Bedienungsanleitung für die Fernbedienung finden Sie Details zu den Bezeichnungen und Funktionen der Schalter und Anzeigen auf der Fernbedienung.

Nous vous remercions pour votre acquisition de ce climatiseur Daikin. Lisez attentivement ce manuel avant d'utiliser le climatiseur. Il vous expliquera comment vous servir correctement de l'appareil et vous guidera en cas de problème. Lorsque vous aurez lu le manuel, rangez-le afin de pouvoir vous y référer ultérieurement. Fonctionnement: consultez le mode d'emploi de la télécommande pour les détails concernant le nom et la fonction des touches et affichages de la télécommande.

Le agradecemos la compra de este acondicionador de aire Daikin. Lea cuidadosamente el manual de funcionamiento antes de utilizar el acondicionador de aire. Dicho manual le indicará cómo utilizar adecuadamente la máquina y le ayudará en caso de avería. Después de leer el manual, consérvelo para consultas futuras. Funcionamiento: consulte el manual de uso del control remoto para obtener detalles sobre los nombres y funciones de los interruptores y pantallas en el control remoto.

La ringraziamo di aver acquistato questo condizionatore d'aria Daikin. Leggere attentamente questo manuale prima di avviare il condizionatore. Ciò permetterà di usare correttamente l'unità e di ottenere un aiuto in caso di anomalia di funzionamento. Dopo aver letto il manuale, conservarlo in un luogo accessibile per una futura necessità. Funzionamento: Per ulteriori dettagli sui nomi e sulle funzioni degli interruttori e dei display del telecomando, consultare il manuale di istruzioni per l'uso.

Σας ευχαριστούμε που αγοράσατε τη συσκευή κλιματισμού. Διαβάστε προσεκτικά αυτές τις οδηγίες χρήσης πριν να χρησιμοποιήσετε τη συσκευή κλιματισμού. Θα σας πουν πως θα χρησιμοποιήσετε σωστά τη μονάδα και θα σας βοηθήσουν αν εμφανιστούν προβλήματα. Αφού διαβάσετε τις οδηγίες, βάλτε τις στο αρχείο σας για μελλοντική αναφορά.

Λειτουργία: δείτε τις οδηγίες λειτουργίας του τηλεχειριστηρίου για λεπτομέρειες σχετικά με τα ονόματα και τις λειτουργίες των διακοπών και των οθονών του τηλεχειριστηρίου.

Wij danken u voor de aankoop van deze Daikin air conditioner. Lees deze bedrijfshandleiding aandachtig door voordat u de airconditioner gebruikt. Het omvat uitleg over het correcte gebruik van de unit en biedt hulp in geval een storing mocht optreden. Gebruik deze handleiding voor verdere raadpleging. Bediening: In de handleiding bij de afstandsbediening vindt u meer informatie over de namen en functies van schakelaars en displays op de afstandsbediening.

Obrigado pela sua compra deste aparelho de ar condicionado Daikin. Leia com atenção este manual de operação antes de proceder à utilização do aparelho de ar condicionado. Este indicará-lhe como deverá utilizar a unidade correctamente e ajudá-lo-á no caso de surgir qualquer problema. Depois de ler o manual, guarde-o num local seguro a fim de o poder consultar caso venha a ser preciso. Funcionamento: consulte o manual de funcionamento do controlo remoto para obter informações sobre os nomes e as funções dos comandos e visores no controlo remoto.

Спасибо за покупку данного кондиционера фирмы Daikin. До начала работы с кондиционером внимательно изучите данное руководство по эксплуатации. В нем излагаются правила надлежащего пользования устройством и приводятся рекомендации пользователю по поиску и устранению неисправностей. После изучения руководства сохраните его для обращений в будущем. Эксплуатация: см. руководство по эксплуатации удаленного контроллера для дополнительной информации о названиях и функциях переключателей и дисплеев на удаленном контроллере.

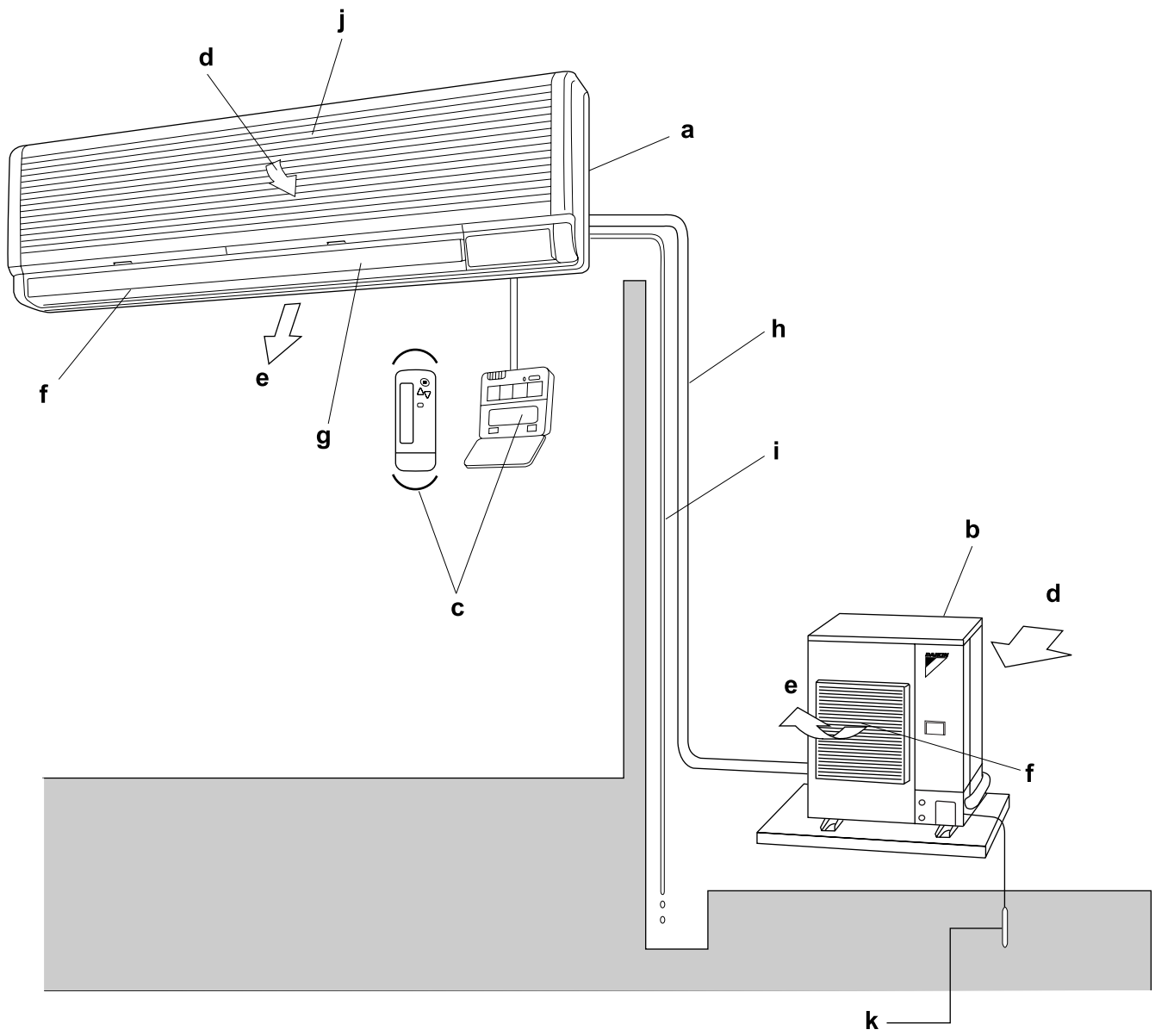

■ DISPOSAL REQUIREMENTS ■ VORSCHRIFTEN ZUR ENTSORGUNG ■ INSTRUCTIONS D'ÉLIMINATION  
■ REQUISITOS PARA LA ELIMINACIÓN ■ SPECIFICHE DI SMALTIMENTO ■ ΠΡΟΪΠΟΘΕΣΕΙΣ ΑΠΟΡΡΙΨΗΣ  
■ VEREISTEN VOOR HET OPRUIJEN ■ REQUISITOS PARA A ELIMINAÇÃO

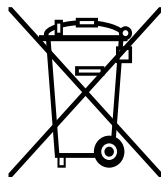

### **(GB) Disposal requirements**

Your air conditioning product is marked with this symbol. This means that electrical and electronic products shall not be mixed with unsorted household waste.

Do not try to dismantle the system yourself: the dismantling of the air conditioning system, treatment of the refrigerant, of oil and of other parts must be done by a qualified installer in accordance with relevant local and national legislation.

Air conditioners must be treated at a specialized treatment facility for re-use, recycling and recovery. By ensuring this product is disposed of correctly, you will help to prevent potential negative consequences for the environment and human health. Please contact the installer or local authority for more information.

Batteries must be removed from the remote controller and disposed of separately in accordance with relevant local and national legislation.

### **(D) Vorschriften zur Entsorgung**

Ihre Klimaanlage ist mit diesem Symbol gekennzeichnet. Das bedeutet, dass elektrische und elektronische Produkte nicht mit unsortiertem Haushaltsabfall entsorgt werden dürfen.

Versuchen Sie auf keinen Fall das System selbst zu demontieren. Die Demontage des Klimaanlage-Systems sowie die Handhabung von Kältemittel, Öl und möglichen weiteren Teilen muss von einem qualifizierten Monteur gemäß den entsprechenden örtlichen und staatlichen Bestimmungen vorgenommen werden.

Klimaanlagen müssen bei einer fachkundigen Einrichtung für Wiederverwendung, Recycling und Wiedergewinnung aufbereitet werden. Indem Sie dieses Produkt korrekt entsorgen, helfen Sie potenzielle negative Folgen für die Umwelt und die Gesundheit der Menschen zu vermeiden. Nehmen Sie bitte hinsichtlich weiterer Informationen Kontakt auf mit dem Monteur oder den örtlichen Behörden.

Die Batterien müssen aus der Fernbedienung entfernt werden und gemäß den entsprechenden örtlichen und staatlichen Vorschriften separat entsorgt werden.

### **(F) Instructions d'élimination**

Cet appareil de conditionnement d'air porte le symbole ci-joint. Ce symbole signifie que les appareils électriques et électroniques doivent être éliminés séparément des ordures ménagères non triées.

N'essayez pas de démonter vous-même l'appareil : le démontage de l'appareil de conditionnement d'air ainsi que le traitement du réfrigérant, de l'huile et d'autres composants doivent être effectués par un installateur qualifié, en accord avec les réglementations locales et nationales en vigueur.

Les appareils de conditionnement d'air doivent être traités dans des installations spécialisées de dépannage, réutilisation ou recyclage. En vous assurant que cet appareil est éliminé correctement, vous contribuez à éviter les conséquences potentiellement néfastes sur l'environnement et la santé. Veuillez contacter votre installateur ou les autorités locales pour plus d'information.

Les piles de la télécommande doivent être enlevées et éliminées séparément, conformément aux réglementations locales et nationales en vigueur.

### **(E) Requisitos para la eliminación**

Su acondicionador de aire está marcado con este símbolo. Esto significa que los productos eléctricos y electrónicos no deben mezclarse con el resto de residuos domésticos no clasificados.

No intente desmontar el sistema usted mismo: El desmantelamiento del acondicionador de aire, así como el tratamiento del refrigerante, aceite y otros componentes, debe ser efectuado por un instalador competente de acuerdo con las normas locales y nacionales aplicables.

Los acondicionadores de aire deben ser tratados en instalaciones especializadas para su reutilización, reciclaje y recuperación. Al asegurarse de deschar este producto de la forma correcta, está contribuyendo a evitar posibles consecuencias negativas para el entorno y para la salud de las personas. Contacte, por favor, con el instalador o con las autoridades locales para obtener más información.

Las pilas del control remoto deben extraerse y eliminarse por separado y de acuerdo con la normativa local y nacional aplicable.

### **(I) Specifiche di smaltimento**

Il climatizzatore è contrassegnato con questo simbolo, ciò significa che i prodotti elettrici ed elettronici non possono essere smaltiti insieme ai rifiuti domestici non differenziati.

Non cercare di rimuovere il sistema da soli: la rimozione del sistema di condizionamento, nonché il recupero del refrigerante, dell'olio e di qualsiasi altra parte devono essere eseguiti da un installatore qualificato in conformità alla legislazione locale e nazionale vigente in materia.

I climatizzatori devono essere trattati presso una struttura specializzata nel riutilizzo, riciclaggio e recupero dei materiali. Il corretto smaltimento del prodotto eviterà le possibili conseguenze negative all'ambiente e alla salute dell'uomo. Per maggiori informazioni contattare l'installatore o le autorità locali.

Le batterie devono essere tolte dal telecomando e smaltite separatamente conformemente alla legislazione locale e nazionale vigente in materia.

### **(GR) Προϋποθέσεις απόρριψης**

Το κλιματιστικό σας επισημαίνεται με αυτό το σύμβολο. Αυτό σημαίνει ότι οι ηλεκτρικές και ηλεκτρονικές συσκευές πρέπει να απορρίπτονται χωριστά από τα οικιακά απορρίμματα.

Μην προσπαθήσετε να αποσυναρμολογήσετε μόνοι σας το σύστημα: Η αποσυναρμολόγηση της μονάδας κλιματισμού, ο χειρισμός του ψυκτικού μέσου, του λαδιού και των άλλων μερών θα πρέπει να γίνεται από κάποιον ειδικευμένο τεχνικό, σύμφωνα με τη σχετική τοπική και εθνική νομοθεσία. Για την εκ νέου χρήση, την ανακύκλωση και την επισκευή, οι μονάδες κλιματισμού θα πρέπει να υφίστανται επεξεργασία σε ειδικές εγκαταστάσεις. Επιβεβαιώνοντας ότι αυτό το προϊόν απορρίπτεται σωστά, θα αποφύγετε ενδεχόμενες αρνητικές συνέπειες για το περιβάλλον και την υγεία.

Παρακαλώ επικοινωνήστε με τον τεχνικό εγκατάστασης ή τις τοπικές αρχές για περισσότερες πληροφορίες.

Οι μπαταρίες θα πρέπει να αφαιρούνται από το τηλεχειριστήριο και να απορρίπτονται ξεχωριστά, σύμφωνα με τη σχετική τοπική και εθνική νομοθεσία.

### **(NL) Vereisten voor het opruimen**

Uw airconditioningproduct draagt dit symbool. Dit betekent dat u geen elektrische en elektronische producten mag mengen met niet-gesorterd huishoudelijk afval.

Probeer niet zelf het systeem te ontmantelen: het ontmantelen van het airconditioningsysteem, behandelen van het koelmiddel, olie en andere onderdelen moet worden uitgevoerd door een bevoegd installateur in overeenstemming met de relevante lokale en nationale reglementeringen.

Airconditioners moeten bij een gespecialiseerd behandelingsbedrijf worden behandeld voor hergebruik, recyclage en terugwinning. Door ervoor te zorgen dat dit product op de correcte manier wordt opgeruimd, helpt u potentiële negatieve gevolgen voor het milieu en de gezondheid te voorkomen. Voor meer informatie, gelieve contact op te nemen met de installateur of de lokale overheid.

De batterijen moeten uit de afstandsbediening worden verwijderd en afzonderlijk opgeruimd in overeenstemming met de relevante lokale en nationale reglementeringen.

### **(P) Requisitos para a eliminação**

O equipamento de ar condicionado que possui este símbolo. Significa que os produtos eléctricos e electrónicos não devem ser misturados com o lixo doméstico indiferenciado.

Não tente desmontar pessoalmente o sistema: o desmantelamento do sistema de ar condicionado e o tratamento do líquido de refrigeração, do óleo e de outros componentes têm de ser feitos por um instalador qualificado, cumprindo a legislação nacional relevante e regulamentos locais aplicáveis.

Os equipamentos de ar condicionado têm de ser processados numa estação de tratamento especializada, para reutilização, reciclagem ou recuperação. Ao certificar-se de que este produto é eliminado correctamente, está a contribuir para evitar as potenciais consequências negativas para o ambiente e para a saúde humana. Contacte o seu instalador ou as autoridades locais, para obter mais informações.

As pilhas do controlo remoto têm de ser retiradas e eliminadas separadamente, cumprindo a legislação nacional e os regulamentos locais aplicáveis.

# CONTENTS

ILLUSTRATION .....	[1]
1. WHAT TO DO BEFORE OPERATION .....	1
2. SAFETY CONSIDERATIONS.....	1
3. OPERATION RANGE .....	3
4. INSTALLATION SITE .....	3
5. OPERATION PROCEDURE .....	4
6. OPTIMUM OPERATION .....	5
7. MAINTENANCE (FOR SERVICE PERSONNEL) .....	5
8. NOT MALFUNCTION OF THE AIR CONDITIONER.....	7
9. TROUBLE SHOOTING .....	7

## Important information regarding the refrigerant used

This product contains fluorinated greenhouse gases covered by the Kyoto Protocol.

Refrigerant type : R410A

GWP<sup>(1)</sup> value : 1975

<sup>(1)</sup>GWP = global warming potential

Periodical inspections for refrigerant leaks may be required depending on European or local legislation. Please contact your local dealer for more information.

## 1. WHAT TO DO BEFORE OPERATION

This operation manual is for the following systems with standard control. Before initiating operation, contact your Daikin dealer for the operation that corresponds to your system.

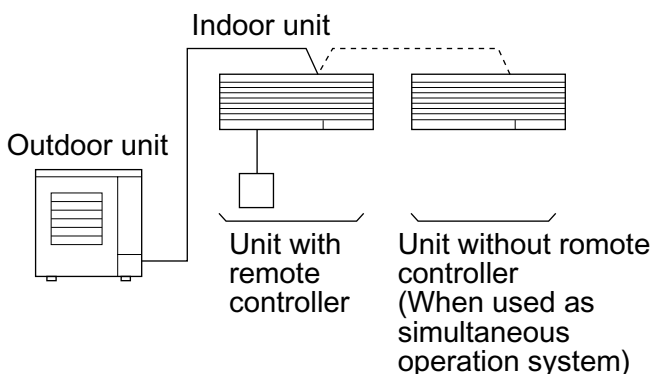

### NOTE

- Read the operation manual that came with the remote controller you are using.

If your installation has a customized control system, ask your Daikin dealer for the operation that corresponds to your system.

- Heat pump type  
This system provides cooling, heating, automatic, program dry, and fan operation modes.

- Cooling only type  
This system provides cooling, program dry, and fan operation modes.

## PRECAUTIONS FOR GROUP CONTROL SYSTEM OR TWO REMOTE CONTROLLER CONTROL SYSTEM

This system provides two other control systems beside individual control (one remote controller controls one indoor unit) system. Confirm the following if your unit is of the following control system type.

- **Group control system**  
One remote controller controls up to 16 indoor units. All indoor units are equally set.
- **Two remote controller control system**  
Two remote controllers control one indoor unit (In case of group control system, one group of indoor units) The unit is individually operated.

### NOTE

- Contact your Daikin dealer in case of changing the combination or setting of group control and two remote controller control systems.

## Names and functions of parts

Refer to figure on page [1]

a	Indoor unit
b	Outdoor unit
c	Remote controller
d	Inlet air
e	Discharged air
f	Air outlet
g	Air flow flap (at air outlet)
h	Refrigerant piping, connection electric wire
i	Drain pipe
j	Air inlet The built-in air filter removes dust and dirt.
k	Ground wire Wire to ground from the outdoor unit to prevent electrical shocks.

## 2. SAFETY CONSIDERATIONS

We recommend that you read this instruction manual carefully before use to gain full advantage of the function of the air conditioner, and to avoid malfunction due to mishandling.

This air conditioner comes under the term “appliances not accessible to the general public”.

- The precautions described below are **WARNING** and **CAUTION**. These are very important precautions concerning safety. Be sure to observe all of them without fail.

**⚠ WARNING** ..These are the matters with possibilities leading to serious consequences such as death or serious injury due to erroneous handling.

**⚠ CAUTION**....These are the matters with possibilities leading to injury or material damage due to erroneous handling including probabilities leading to serious consequences in some cases.

- After reading, keep this manual at a place where any user can read at any time. Furthermore, make certain that this operation manual is handed to a new user when he takes over the operation.

**⚠ WARNING**

**Avoid exposure of your body directly to the cold air for a long time, or avoid excessive exposure of your body to the cold air.**

Otherwise, your physical condition may be deteriorated and/or your health may be ruined.

**When the air conditioner is in abnormal conditions (smell of something burning, etc), unplug the power cord from the outlet, and contact the dealer where you purchased the air conditioner.**

Continued operation under such circumstances may result in a failure, electric shock, and fire.

**Ask your dealer for installation of the air conditioner.**

Incomplete installation performed by yourself may result in a water leakage, electric shock, and fire.

**Ask your dealer for improvement, repair, and maintenance.**

Incomplete improvement, repair, and maintenance may result in a water leakage, electric shock, and fire.

**Do not insert your finger, a stick, etc., into the air inlet, outlet, and fan blades.**

A fan in high-speed running may result in injury.

**For refrigerant leakage, consult your dealer.**

When the air conditioner is to be installed in a small room, it is necessary to take proper measures so that the amount of any leaked refrigerant does not exceed the limiting concentration even when it leaks. If the refrigerant leaks exceeding the level of limiting concentration, an oxygen deficiency accident may happen.

**For installation of separately sold component parts, ask a specialist.**

Be sure to use the separately sold component parts designated by our company.

Incomplete installation performed by yourself may result in a water leakage, electric shock, and fire.

**Ask your dealer to move and reinstall the air conditioner.**

Incomplete installation may result in a water leakage, electric shock, and fire.

**Do not use any fuse with improper capacity.**

The use of a piece of wire and whatnot may result in a failure and fire.

**The refrigerant in the air conditioner is safe and normally does not leak. If the refrigerant leaks inside the room, the contact with a fire of a burner, a heater or a cooker may result in a harmful gas.**

Do not use the air conditioner until when a service person confirms to finish repairing the portion where the refrigerant leaks.

**Be sure to establish an earth.**

Do not earth the unit to a utility pipe, arrester, or telephone earth.

Incomplete earth may cause electrical shock, or fire. A high surge current from lightning or other sources may cause damage to the air conditioner.

**Be sure to install an earth leakage breaker.**

Failure to install an earth leakage breaker may result in electric shocks, or fire.

**Consult the dealer if the air conditioner submerges owing to a natural disaster, such as a flood or typhoon.**

Do not operate the air conditioner in that case, or otherwise a malfunction, electric shock, or fire may result.

**⚠ CAUTION**

**Do not use the air conditioner for other purposes.**

Do not use the air conditioner for a special application such as the storage of foods, animals and plants, precision machines, and art objects as otherwise the deterioration of quality may result.

**Do not remove the air outlet of the outdoor unit.**

The fan may get exposed and result in injury.

**When the air conditioner is used in combination with burners or heaters, perform sufficient ventilation.**

Insufficient ventilation may result in an oxygen deficiency accident.

**Check and make sure that foundation blocks are not damaged after a long use.**

If they are left in a damaged condition, the unit may fall and result in injury.

**Neither place a flammable spray bottle near the air conditioner nor perform spraying.**

Doing so may result in a fire.

**To clean the air conditioner, stop operation, and unplug the power cord from the outlet.**

Otherwise, an electric shock and injury may result.

**Do not operate the air conditioner with a wet hand.**

An electric shock may result.

**Do not place items that might be damaged by water under the indoor unit.**

Water may condensate and drip if the humidity reaches 80% or if the drain exit gets clogged.

**Do not place a burner or heater at a place directly exposed to the wind from the air conditioner.**

Incomplete combustion of the burner or heater may result.

**Do not allow a child to mount on the outdoor unit or avoid placing any object on it.**

Falling or tumbling may result in injury.

**Do not expose animals and plants directly to the wind.**

Adverse influence to animals and plants may result.

**Do not wash the air conditioner with water.**

Electric shock or fire may result.

**Do not install the air conditioner at any place where flammable gas may leak out.**

If the gas leaks out and stays around the air conditioner, a fire may break out.

**Execute complete drain piping for perfect drainage.**

Incomplete piping may result in a water leakage.

**The appliance is not intended for use by young children or infirm persons without supervision.**

**Young children should be supervised to ensure that they do not play with the appliance.**

**Consult with installation contractor for cleaning the inside of the air conditioner.**

Wrong cleaning may make the plastics parts broken or cause failure of water leakage or electric shock.

**Do not touch the air inlet or aluminium fin of the air conditioner.**

Otherwise, injury may be caused.

**Do not start or stop operating the air conditioner with the power supply breaker turned ON or OFF.**

Otherwise, fire or water leakage may result.

Furthermore, the fan will rotate abruptly if power failure compensation is enabled, which may result in injury.

**Do not place objects in direct proximity of the outdoor unit and do not let leaves and other debris accumulate around the unit.**

Leaves are a hotbed for small animals which can enter the unit. Once in the unit, such animals can cause malfunctions, smoke or fire when making contact with electrical parts.

**Never touch the internal parts of the remote controller.**

Do not remove the front panel. Some parts inside are dangerous to touch, and a machine trouble may happen.

For checking and adjusting the internal parts, contact your dealer.

**Avoid placing the remote controller in a spot splashed with water.**

Water coming inside the machine may cause an electric leak or may damage the internal electronic parts.

**Watch your steps at the time of air filter cleaning or inspection.**

High-place work is required, to which utmost attention must be paid.

If the scaffold is unstable, you may fall or topple down, thus causing injury.

### 3. OPERATION RANGE

If the temperature or the humidity is beyond the following conditions, safety devices may work and the air conditioner may not operate, or sometimes, water may drop from the indoor unit.

#### COOLING

OUTDOOR UNIT	INDOOR		OUTDOOR TEMPERATURE
	TEMPERATURE	HUMIDITY	
RZQ100	DB	18 to 37	80% or below DB - 15 to 50
	WB	12 to 28	
RQ100	DB	18 to 37	80% or below DB - 5 to 46
	WB	12 to 28	
RR100	DB	18 to 37	80% or below DB - 15 to 46
	WB	12 to 28	

#### HEATING

OUTDOOR UNIT	INDOOR TEMPERATURE	OUTDOOR TEMPERATURE
RZQ100	DB 10 to 27	DB -19.5 to 21
		WB -20 to 15.5
RQ100	DB 10 to 27	DB -9 to 21
		WB -10 to 15

For Australia model Only

#### COOLING

OUTDOOR UNIT	INDOOR		OUTDOOR TEMPERATURE
	TEMPERATURE	HUMIDITY	
RZQ100	DB	20 to 37	80% or below DB - 5 to 46
	WB	14 to 28	

#### HEATING

OUTDOOR UNIT	INDOOR TEMPERATURE	OUTDOOR TEMPERATURE
RZQ100	DB 10 to 27	DB -14 to 21
		WB -15 to 15.5

DB: Dry bulb temperature

WB: Wet bulb temperature

The setting temperature range of the remote controller is 16°C to 32°C.

### 4. INSTALLATION SITE

**Regarding places for installation**

- Is the air conditioner installed at a well-ventilated place where there are no obstacles around?
- Do not use the air conditioner in the following places.
  - a. Filled with much mineral oil such as cutting oil
  - b. Where there is much salt such as a beach area

- c. Where sulfured gas exists such as a hot-spring resort
  - d. Where there are considerable voltage fluctuations such as a factory or plant
  - e. Vehicles and vessels
  - f. Where there is much spray of oil and vapor such as a cookery, etc.
  - g. Where there are machines generating electromagnetic waves
  - h. Filled with acid and/or alkaline steam or vapor
- **Is a snow protection measure taken?**  
For details, consult your dealer.

### Regarding wiring

- **All wiring must be performed by an authorized electrician.**  
To do wiring, ask your dealer. Never do it by yourself.
- **Make sure that a separate power supply circuit is provided for this air conditioner and that all electrical work is carried out by qualified personnel according to local laws and regulations.**

### Pay attention to running noises, too

- **Are the following places selected?**
  - a. A place that can sufficiently withstand the weight of the air conditioner with less running noises and vibrations.
  - b. A place where the hot wind discharged from the air outlet of the outdoor unit and the running noises.
- **Are you sure that there are no obstacles near the air outlet of the outdoor unit?**  
Such obstacles may result in declined performance and increased running noises.
- **If abnormal noises occur in use, consult your dealer.**

### Regarding drainage of drain piping

- **Is the drain piping executed to perform complete drainage?**  
If proper drainage is not carried out from the outdoor drain pipes during air-conditioning operation, chances are that dust and dirt are clogged in the pipe. This may result in a water leakage from the indoor unit. Under such circumstances, stop the operation of the air conditioner, and then consult your dealer or our service station.

## 5. OPERATION PROCEDURE

Read the operation manual that came with the remote controller.

- Operating procedure varies with heat pump type and cooling only type. Contact your Daikin dealer to confirm your system type.

- To protect the unit, turn on the main power switch 6 hours before operation.
- If the main power supply is turned off during operation, operation will restart automatically after the power turns back on again.

### [EXPLANATION OF HEATING OPERATION]

#### DEFROST OPERATION

- As the frost on the coil of an outdoor unit increase, heating effect decreases and the system goes into DEFROST OPERATION.
- The indoor unit fan stops and the remote controller display shows “”.
- After 6 to 8 minutes (maximum 10 minutes) of DEFROST OPERATION, the system returns to HEATING OPERATION.

#### Regarding outside air temperature and heating capacity

- The heating capacity of the air conditioner declines as the outside air temperature falls. In such a case, use the air conditioner in combination with other heating systems.
- A warm air circulating system is employed, and therefore it takes some time until the entire room is warmed up after the start of operation.
- An indoor fan runs to discharge a gentle wind automatically until the temperature inside the air conditioner reaches a certain level. At this time, the remote controller displays “”. Leave it as it stands and wait for a while.
- When the warm air stays under the ceiling and your feet are cold, we recommend that you use a circulator (a fan to circulate the air inside the room). For details, consult your dealer.



#### AIR FLOW DIRECTION ADJUST

- There are 2 ways of adjusting the air discharge angle.

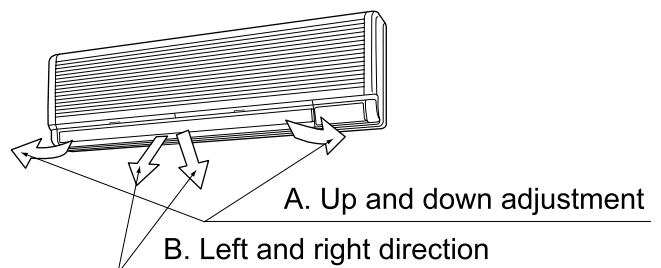

#### A. UP AND DOWN DIRECTION

Press the AIR FLOW DIRECTION ADJUST button to select the air direction as shown below.



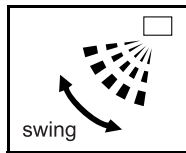

The AIR FLOW FLAP display swings as shown below and the air flow direction continuously varies. (Automatic swing setting)



Press AIR FLOW DIRECTION ADJUST button to select the air flow direction of your choice.

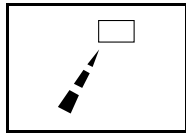

The AIR FLOW FLAP display stops swinging and the air flow direction is fixed (Fixed air flow direction setting).

## MOVEMENT OF THE AIR FLOW FLAP

For the following conditions, micro computer controls the air flow direction so it may be different from the display.

Operation mode	Cooling	Heating
Operation condition	<ul style="list-style-type: none"> <li>When room temperature is lower than the set temperature</li> <li>When operating continuously at horizontal air flow direction</li> </ul>	<ul style="list-style-type: none"> <li>When room temperature is higher than the set temperature</li> <li>At defrost operation</li> </ul>

Operation mode includes automatic operation.

### Recommended flap positions

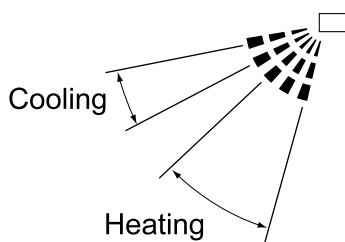

We recommend using the fan in the position listed above when fixing the fan direction.

## B. LEFT AND RIGHT DIRECTION

Grasp the air flow blades at the tip and move the blades to the left and right.

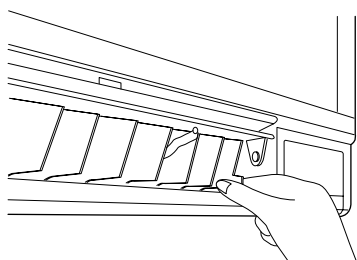

## NOTE

- Only make adjustments after you have stopped the air flow direction swing in a position where adjustments are possible. Your hand may get caught if you attempt to make adjustments while the unit is swinging.

## 6. OPTIMUM OPERATION

Observe the following precautions to ensure the system operates.

- Adjust the room temperature properly for a comfortable environment. Avoid excessive heating or cooling.
- Prevent direct sunlight from entering a room during cooling operation by using curtains or blinds.
- Ventilate the room regularly. Using the unit for long periods of time requires attentive ventilation of the room.
- Keep doors and windows closed. If the doors and windows remain open, room air will flow out and cause to decrease the effect of cooling and heating.
- Do not place other heaters directly below the indoor unit. They may deform due to the heat.
- Never place objects near the air inlet and the air outlet of the unit. It may cause deterioration in the effect or stop in the operation.
- Turn off the main power supply switch when it is not used for long periods of time. When the main power switch is turned on, some watts of electricity is being used even if the system is not operating. Turn off the main power supply switch for saving energy. When reoperating, turn on the main power supply switch 6hours before operation for smooth running (Refer to MAINTENANCE).
- When the display shows “”, ask a qualified service person to clean the filters (Refer to MAINTENANCE).
- Fully use the function of air flow direction adjust. Cold air gathers on the floor, and warm air gathers in the ceiling. Set the air flow direction parallel during cooling or dry operation, and set it downwards during heating operation. Do not let the air blow directly to a person.

## 7. MAINTENANCE (FOR SERVICE PERSONNEL)

**ONLY A QUALIFIED SERVICE PERSON IS ALLOWED TO PERFORM MAINTENANCE**

## IMPORTANT!

- **BEFORE OBTAINING ACCESS TO TERMINAL DEVICES, ALL POWER SUPPLY CIRCUITS MUST BE INTERRUPTED**
- To clean the air conditioner, be sure to stop operation, and turn the power switch off. Otherwise, an electric shock and injury may result.
- Do not wash the air conditioner with water. Doing so may result in an electric shock.
- Be careful with a scaffold or staging. Caution must be exercised because of work at a high place.

## HOW TO CLEAN THE AIR FILTER

Clean the air filter when the display shows “”. Increase the frequency of cleaning if the unit is installed in a room where the air is extremely contaminated.

(As a yardstick for regulating yourself, consider cleaning the filter once every two weeks.)

### 1. Remove the air filters.

Pull the handle in the direction of the arrow.

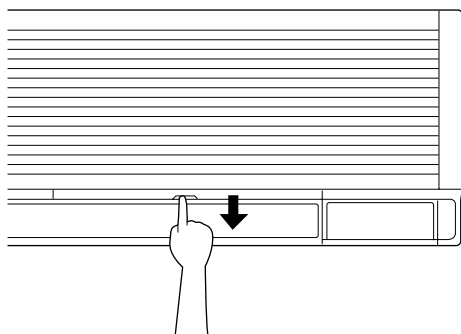

### 2. Clean the air filter.

Use vacuum cleaner **A)** or wash the air filter with water **B)**.

**A)** Using a vacuum cleaner



**B)** Washing with water

When the air filter is very dirty, use soft brush and neutral detergent.



Remove water and dry in the shade.

## NOTE

- Do not wash the air conditioner with hot water of more than 50°C, as doing so may result in discoloration and/or deformation.
- Do not expose it to fire, as doing so may result in burning.

### 3. Reset the air filter in place.

After cleaning the filter, do not forget to put it back the way it was before.

### 4. After turning on the power, press AIR FILTER CLEANING TIME ICON RESET BUTTON.

The display “” vanishes.

## HOW TO CLEAN AIR OUTLET AND OUTSIDE PANELS

- Clean with soft cloth.
- When it is difficult to remove stains, use water or neutral detergent.

## NOTE

- Do not use gasoline, benzene, thinner, polishing powder, liquid insecticide. It may cause discoloring or warping.
- Do not use water or air of 50°C or higher for cleaning air filters and outside panels.

## START UP AFTER A LONG STOP

### Confirm the following.

- Check that the air inlet and outlet are not blocked. Remove any obstacle.
- Check if the earth is connected. Might there be a broken wire somewhere? Contact your dealer if there are any problems.

### Clean the air filter and outside panels.

- After cleaning the air filter, make sure to attach it.

### Turn on the main power supply switch.

- The display on the remote controller will be shown when the power is turned on.
- To protect the unit, turn on the main power switch at least 6 hours before operation.

## WHAT TO DO WHEN STOPPING THE SYSTEM FOR A LONG PERIOD

### Turn on FAN OPERATION for a half day and dry the unit.

- Read the operation manual that came with the remote controller.

### Cut off the power supply.

- When the main power switch is turned on, some watts of electricity is being used even if the system is not operating. Turn off the main power supply switch for saving energy.
- The display on the remote controller will vanish when the main power switch is turned off.

### Clean the air filter and the exterior.

- Be sure to replace the air filter to its original place after cleaning. Refer to “MAINTENANCE”.

## 8. NOT MALFUNCTION OF THE AIR CONDITIONER

The following symptoms do not indicate air conditioner malfunction

### I. THE SYSTEM DOES NOT OPERATE

- **The system does not restart immediately after the ON/OFF button is pressed.**

If the OPERATION lamp lights, the system is in normal condition.

It does not restart immediately because a safety device operates to prevent overload of the system. After 3 minutes, the system will turn on again automatically.

- **The system does not restart immediately when TEMPERATURE SETTING button is returned to the former position after pushing the button.**

If the OPERATION lamp lights, the system is in normal condition.

It does not restart immediately because a safety device operates to prevent overload of the system. After 3 minutes, the system will turn on again automatically.

- **The system does not start when the display shows “” and it flashes for few seconds after pressing an operation button.**

This is because the system is under centralized control. Flashes on the display indicates that the system cannot be controlled by the remote controller.

- **The system does not start immediately after the power supply is turned on.**

Wait one minute until the micro computer is prepared for operation.

### II. WHITE MIST COMES OUT OF A UNIT

- **When humidity is high during cooling operation (In oily or dusty places)**

If the inside of an indoor unit is extremely contaminated, the temperature distribution inside a room becomes uneven. It is necessary to clean the inside of the indoor unit. Ask your Daikin dealer for details on cleaning the unit. This operation requires a qualified service person.

- **When the system is changed over to HEATING OPERATION after DEFROST OPERATION.**

Moisture generated by DEFROST becomes steam and exists.

### III. NOISE OF AIR CONDITIONERS

- **A ringing sound after the unit is started.**

This sound is generated by the temperature regulator working.

It will quiet down after about a minute.

- **A continuous flow “Shuh” sound is heard when the systems is in COOLING or DEFROST OPERATION.**

This is the sound of refrigerant gas flowing through both indoor and outdoor units.

- **A “Shuh” sound which is heard at the start or immediately after the stop of operation or which is heard at the start or immediately after the stop of DEFROST OPERATION.**

This is the noise of refrigerant caused by flow stop and flow change.

- **A continuous low “Shah” sound is heard when the system is in COOLING OPERATION or at a stop.**

The noise is heard when the drain pump is in operation.

- **A “Pishi-pishi” squeaking sound is heard when the system is in operation or after the stop of operation.**

Expansion and contraction of plastic parts caused by temperature change makes this noise.

### IV. DUST FROM THE UNITS

- **Dust may blow out from the unit after starting operation from long resting time.**

Dust absorbed by the unit blows out.

### V. THE UNITS GIVE OFF ODORS

The unit absorbs the smell of rooms, furniture, cigarettes, etc., and then emits them.

### VI. THE LIQUID CRYSTAL OF THE REMOTE CONTROLLER SHOW “88”

- **It happens immediately after the main power supply switch is turned on.**

This shows that the remote controller is in normal condition.

This continues temporary.

## 9. TROUBLE SHOOTING

1. **If one of the following malfunctions occurs, take the measures shown below and contact your Daikin dealer.**

The system must be repaired by a qualified service person.

### — WARNING —

**When the air conditioner is in abnormal conditions (smell of something burning, etc), unplug the power cord from the outlet, and contact your dealer**

Continued operation under such circumstances may result in a failure, electric shock, and fire.

- If a safety device such as a fuse, a breaker or an earth leakage breaker frequently actuates;  
**Measure:** Do not turn on the main power switch.
- If the ON/OFF switch does not properly work;  
**Measure:** Turn off the main power switch.

- If water leaks from unit.  
**Measure:** Stop the operation.
- If the display “”, “UNIT No.”, and the OPERATION lamp flash and the “MALFUNCTION CODE” appears.

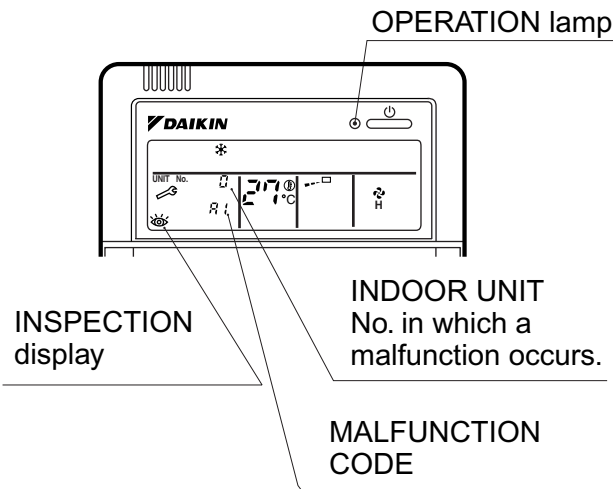

**Measure:** Notify your Daikin dealer and inform him/her of the display.

**II. If the system does not properly operate except for the above mentioned case, and none of the above mentioned malfunctions is evident, investigate the system according to the following procedures.**

**1. If the system does not operate at all.**

- Check if there is a power failure.  
Wait until power is restored. If power failure occurs during operation, the system automatically restarts immediately after the power supply recovers.
- Check if no fuse has blown.  
Turn off the power supply.
- Check if the breaker is blown.  
Turn the power on with the breaker switch in the off position.  
Do not turn the power on with the breaker switch in the trip position.  
(Contact your dealer.)

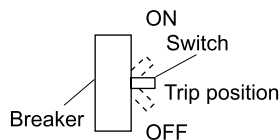

**2. If the system stops operating after operating the system.**

- Check if the air inlet or outlet of outdoor or indoor unit is blocked by obstacles.  
Remove the obstacle and make it well-ventilated.
- Check if the air filter is clogged.  
Ask a qualified service person to clean the air filters (Refer to MAINTENANCE).

**3. The system operates but it does not sufficiently cool or heat.**

- If the air inlet or outlet of the indoor or the outdoor unit is blocked with obstacles.  
Remove the obstacle and make it well-ventilated.
- If the air filter is clogged.  
Ask a qualified service person to clean the air filters (Refer to MAINTENANCE).
- If the set temperature is not proper (Refer to ADJUSTMENT).
- If the FAN SPEED button is set to LOW SPEED (Refer to ADJUSTMENT).
- If the air flow angle is not proper (Refer to ADJUSTING THE AIR FLOW DIRECTION).
- If the doors or the windows are open. Shut doors or windows to prevent wind from coming in.
- If direct sunlight enters the room (when cooling).  
Use curtains or blinds.
- When there are too many inhabitants in the room (when cooling).  
Cooling effect decreases if heat gain of the room is too large.
- If the heat source of the room is excessive (when cooling).  
Cooling effect decreases if heat gain of the room is too large.

**DAIKIN INDUSTRIES, LTD.**

Head office:  
Umeda Center Bldg., 2-4-12, Nakazaki-Nishi,  
Kita-ku, Osaka, 530-8323 Japan

Tokyo office:  
JR Shinagawa East Bldg., 2-18-1, Konan,  
Minato-ku, Tokyo, 108-0075 Japan

**DAIKIN EUROPE NV**

Zandvoordestraat 300, B-8400 Oostende, Belgium