



# DSR1

## Installation and Operating Instructions



**GB**  
Output 12/2015



## Safety

### Please read and keep in a safe place



Please read through these instructions carefully before installing or operating. Following the installation, pass the instructions on to the operator.

These instructions can also be found at [www.docuthek.com](http://www.docuthek.com).

### Explanation of symbols

- , **1**, **2**, **3**... = Action
- ▷ = Instruction

### Liability

We will not be held liable for damages resulting from non-observance of the instructions and non-compliant use.

### Safety instructions

Information that is relevant for safety is indicated in the instructions as follows:

#### **DANGER**

Indicates potentially fatal situations.

#### **WARNING**

Indicates possible danger to life and limb.

#### **! CAUTION**

Indicates possible material damage.

All work and settings in the "Expert" chapters may only be carried out by a qualified technician. Electrical interventions may only be carried out by a qualified electrician. The heating system must be disconnected from the power supply before any electrical work is carried out on the unit.

### Conversion

All technical changes are prohibited.

### Transport

On receipt of the product, check that the delivery is complete. Report any transport damage immediately.

### Storage

Store the product in a dry place. Ambient temperature: see Technical data.

## Table of contents

---

### Table of contents

<b>Safety</b> .....	<b>3</b>	<b>User – Settings</b> .....	<b>12</b>
Please read and keep in a safe place .....	3	Language .....	12
Explanation of symbols .....	3	Time .....	12
Liability .....	3	Weekday .....	13
Safety instructions .....	3	Reset .....	13
Conversion .....	3	Parameter .....	13
Transport .....	3	<b>User – Commissioning</b> .....	<b>14</b>
Storage .....	3	<b>User – Parameters</b> .....	<b>14</b>
<b>Table of contents</b> .....	<b>4</b>	List of parameters P01 to P11 .....	14
<b>Verify type of application</b> .....	<b>8</b>	Explanation of the parameters .....	14
<b>Part designations</b> .....	<b>8</b>	P00 Error list .....	14
<b>Selector switch and display</b> .....	<b>9</b>	P01 Time .....	14
Selector switch .....	9	P02 Weekday .....	15
Display .....	9	P03 Day's production .....	15
Standby .....	9	P04 Total production .....	15
Automatic mode .....	9	P05 Pump Kick ON Time/	
Temperature display F1 (Collector/storage tank) .....	10	P06 Pump Kick OFF Time .....	15
Temperature display F2 (Additional sensor) .....	10	P07 Reheating ON Time/	
Temperature display F3 (Tank top) .....	10	P08 Reheating OFF Time .....	15
Temperature display F4 (Tank bottom) .....	10	P09 Circulation pump ON time	
Display Output .....	11	P10 Circulation pump OFF time .....	15
User settings .....	11	P11 Antilegion start .....	15
Expert settings .....	11		

**Technician - Installation . . . . . 16**

**Technician - Electrical connections . . . . . 16**

Define application . . . . . 16

System schemes . . . . . 17

Key . . . . . 17

System 1 (1 collector, 1 buffer storage tank) . . . . . 17

System 2 (1 solid fuel boiler, 1 storage tank or 1 solid fuel boiler, 2 storage tanks with switch-over valve) . . . . . 18

System 3 (1 collector, 1 storage tank, 1 solid fuel boiler) . . . . . 19

System 4 (2 collectors, 1 storage tank, 2 collector pumps) . . . . . 19

System 5 (1 collector, 2 storage tanks, 1 switch-over valve) . . . . . 20

System 6 (1 collector, 2 storage tanks, 2 charge pumps) . . . . . 21

System 7 (1 collector, 1 storage tank or 2 storage tanks) . . . . . 22

System 8 (1 collector, 1 storage tank, return temperature increase) . . . . . 23

System 9 (1 solid fuel boiler, 1 storage tank, return temperature increase with mixer) . . . . . 23

System 10 (1 collector, 2 storage tanks, refeeding pump) . . . . . 24

System 11 (1 collector, 1 storage tank, 2 feeding areas) . . . . . 24

System 12 (1 collector, 1 storage tank, 3 feeding areas) . . . . . 25

System 13 (1 collector, 1 storage tank, drain-back system) . . . . . 26

Special functions . . . . . 28

Circulation pump . . . . . 28

Reheating . . . . . 28

Return temperature increase . . . . . 29

Connection diagram controller in socket . . . . . 30

Connection RDS2/EKSRDS2A . . . . . 31

**Technician – Settings . . . . . 32**

Assistant (system installation) . . . . . 32

Parameters . . . . . 33

Change Code no. . . . . 33

Set parameters . . . . . 33

Relaistest (Relay test) . . . . . 34

Reset . . . . . 34

**Technician – Parameters . . . . . 36**

List of parameters P21 to P110 . . . . . 36

Explanation of the parameters . . . . . 37

P21 Code No. . . . . 37

P22 Select system. . . . . 37

P23 Speed level value . . . . . 37

P24 Op. mode speed cntrl . . . . . 37

P25 Speed level (Manual) . . . . . 38

P26 Min. Speed level (Auto) . . . . . 38

P27 Max. Speed level (Auto) . . . . . 38

P28 Temperature difference for 100% control . . . . . 38

P30 Switch-on threshold 1 . . . . . 38

P31 Switch-off threshold 1 . . . . . 38

P32 Switch-on threshold 2, . . . . . 38

P33 Switch-off threshold 2 . . . . . 38

P34 Hysteresis reheating. . . . . 39

P40 Collector enable temperature, . . . . . 39

P41 Collector disable temperature . . . . . 39

P42 Maximum collector temperature. . . . . 39

P43 Enable temperature 2nd heat gen. (solid fuel boiler) . . . . . 39

P44 Maximum boiler temperature (solid fuel boiler) . . . . . 40

P45 Collector safety temperature . . . . . 40

P46 Storage tank recooling switching threshold . . . . . 40

P47 Reheating set temperature . . . . . 40

P50 Maximum storage tank temperature, tank 1. . . . . 40

P51 Maximum storage tank temperature, tank 2. . . . . 41

P52 Tolerance during solar production . . . . . 41

P53 Hot water short heating . . . . . 41

P54 Function A2 and/or A3 . . . . . 42

P55 Circulation pump on time . . . . . 42

P56 Circulation pump blocking . . . . . 42

P57 Minimum return flow temperature. . . . . 42

P58 Mixer dynamic Open, . . . . . 42

P59 Mixer dynamic Close . . . . . 42

P60 Kick duration . . . . . 43

P61 Kick pause . . . . . 43

## Table of contents

---

P62 Measuring time for 0.5 K increase . . . . .	43
P63 Frost protection temperature . . . . .	43
P70 Pulse rate. . . . .	44
P71 Pulse rate unit . . . . .	44
P72 Vol. flow distribution (system with 2 collectors). . . . .	44
P75 Vol. flow - collector1 (estimated production). . . . .	44
P76 Vol. flow - collector2 (estimated production). . . . .	44
P78 Mixing ratio. . . . .	45
P79 Glycol type. . . . .	45
P84 Max tank output. . . . .	45
P85 Max tank input active . . . . .	45
P86 Max tank output active. . . . .	45
P87 Filling time . . . . .	45
P99 Software number and index . . . . .	45
P101 Speed control variant . . . . .	46
P102 PWM base frequency. . . . .	46
P103 PWM ratio ON . . . . .	46
P104 PWM ratio OFF . . . . .	46
P105 PWM ratio Pmin. . . . .	46
P106 PWM ratio Pmax . . . . .	46
P107 PWM ratio Povrspe . . . . .	46
P108 Voltage 0% . . . . .	46
P109 Voltage 100% . . . . .	46
P110 Voltage OFF . . . . .	46
<b>Further functions . . . . .</b>	<b>47</b>
Pump blocking protection . . . . .	47
Pump stop (temperature check) . . . . .	47
<b>Expert – Checklist for commissioning . . . . .</b>	<b>47</b>
<b>Accessories . . . . .</b>	<b>48</b>
Sensor (PT 1000) . . . . .	48
Cylinder sensor SPF . . . . .	48
Sensor values . . . . .	48

**Troubleshooting . . . . . 50**

**Technical Specifications . . . . . 50**

**Glossary . . . . . 51**

Flow and return flow temperature. . . . . 51

Set temperature . . . . . 51

Heat source . . . . . 51

Circulation pump . . . . . 51

Return temperature increase . . . . . 51

Legionella. . . . . 51

## Part designations

### Verify type of application

Differential controller with base for wall mounting.

For use with flat and tubular collectors – as well as solid fuel boilers and layer storage systems – for controlling hydraulic systems:

- 1 collector, 1 buffer storage tank
- 1 solid fuel boiler, 1 storage tank or 1 solid fuel boiler, 2 storage tanks with switch-over valve)
- 1 collector, 1 storage tank, 1 solid fuel boiler
- 2 collectors, 1 storage tank, 2 collector pumps
- 1 collector, 2 storage tanks, 1 switch-over valve
- 1 collector, 2 storage tank, 2 charge pumps
- 1 collector, 1 storage tank or 2 storage tanks
- 1 collector, 1 storage tank, return temperature increase
- 1 collector, 1 storage tank, return temperature increase with mixer
- 1 collector, 2 storage tanks, refeeding pump
- 1 collector, 2 storage tank, 2 feeding areas
- 1 collector, 2 storage tank, 3 feeding areas
- 1 collector, 1 storage tank, drain-back system

Explanation, see page 16 (Technician - Electrical connections).

The function is only guaranteed within the specified limits, see page 50 (Technical Specifications).

Any other use will be deemed improper use.

### Part designations

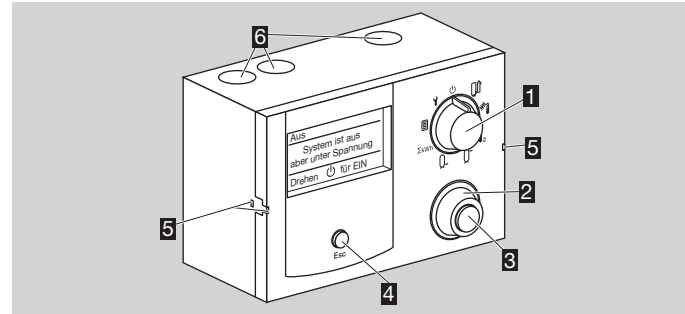

- 1** Selector switch
- 2** Rotary knob for changing set values and selection of parameters and installation types
- 3** OK button for confirming set values
- 4** Back button
- 5** Assembly holder of the controller
- 6** Cable feed-throughs



## Selector switch and display

### Selector switch

⏻	Standby (no function)
📄	Automatic mode
🔧	Display of the set installation scheme with actuators and sensors
🌡️	Temperature display of collector/solid fuel boiler
🌡️ <sub>2</sub>	Temperature display of additional sensor (storage tank 2 bottom, collector 2)
Q+	Temperature display Tank top
Q-	Temperature display Tank bottom
ΣkWh	Display of day, week, month or total production
📄	User settings
🔧	Technician Settings

### Display

- ▷ The display is dependent on the selector switch position.
- ▷ In the event of an error in the installation configuration, the display lights up red, see page 50 (Troubleshooting)

### Standby

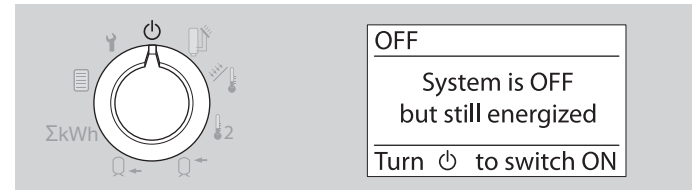

- ▷ The controller has power.

### Automatic mode



- ▷ The currently selected installation scheme with actuators and sensors is displayed.
- ▷ With the rotary knob it is possible to select whether the designations (e.g. F1, F2, A1) or the momentary statuses and temperatures are displayed at the actuators and sensors.

## Selector switch and display

### Temperature display F1 (Collector/storage tank)

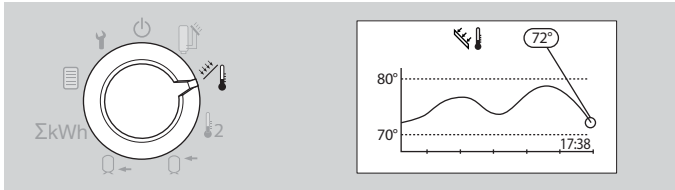

- ▷ The display shows the temperature currently measured by sensor F1 at the collector, or alternatively for some hydraulic systems the temperature at the sensor on the solid fuel boiler.
- ▷ In addition, the temperature curve of the sensor for the last hour is displayed.
- ▷ The display is refreshed every minute, the current time is shown in the bottom right of the diagram.

### Temperature display F2 (Additional sensor)

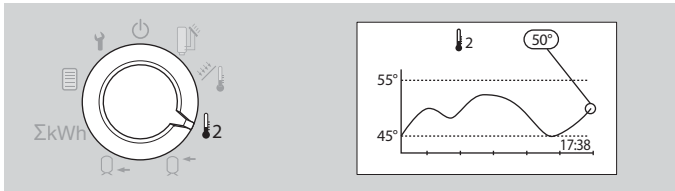

- ▷ The display shows the temperature currently measured by sensor F2.
- ▷ In addition, the temperature curve of the sensor for the last hour is displayed.
- ▷ The display is refreshed every minute, the current time is shown in the bottom right of the diagram.
- ▷ The display shows "Not connected" if F2 is not installed.

### Temperature display F3 (Tank top)

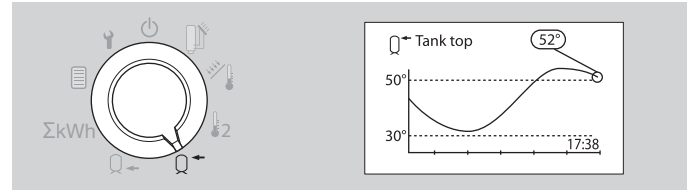

- ▷ The display shows the temperature currently measured by sensor F3.
- ▷ In addition, the temperature curve of the sensor for the last hour is displayed.
- ▷ The display is refreshed every minute, the current time is shown in the bottom right of the diagram.
- ▷ The display shows "Not connected" if F3 is not installed.

### Temperature display F4 (Tank bottom)

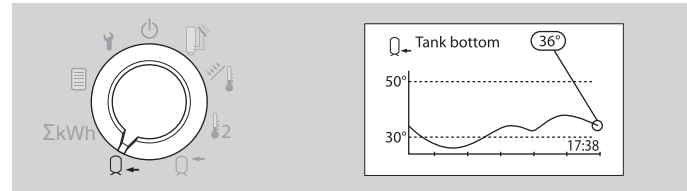

- ▷ The display shows the temperature currently measured by sensor F4 in the lower half of the storage tank.
- ▷ In addition, the temperature curve of the sensor for the last hour is displayed.
- ▷ The display is refreshed every minute, the current time is shown in the bottom right of the diagram.

## Display Output

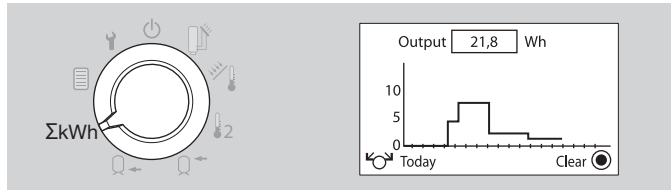

- ▷ The display shows the energy produced via the collectors, either for today, yesterday, the current week, last week, the current month or the last year (the last 365 days).
- ▷ The display switches automatically between Wh, kWh and MWh.

## User settings

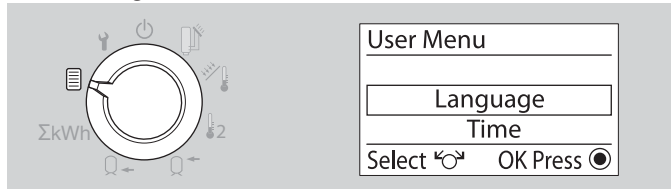

- ▷ The display shows the setting possibilities with which the user can adapt the heating system to the personal requirements.

## Expert settings

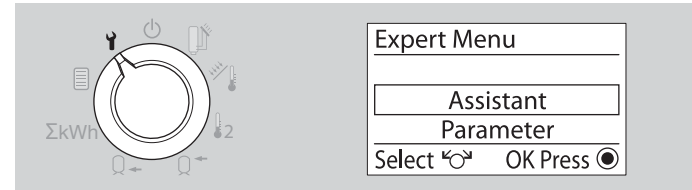

- ▷ The display shows the setting possibilities for the expert during commissioning.
- ▷ A code number has to be entered before the settings can be changed.

## User – Settings

### User – Settings

- 1 Turn selector switch to  "User settings".

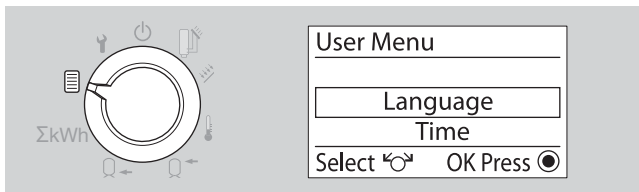

- ▷ The display shows the options with which the heating system can be adapted to the user's personal requirements.
- 2 Select the desired option (**Language, Time, Weekday, Parameter** or **Reset**) using the rotary knob.
  - 3 Press the OK button.

### Language

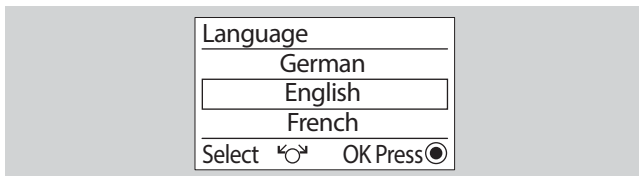

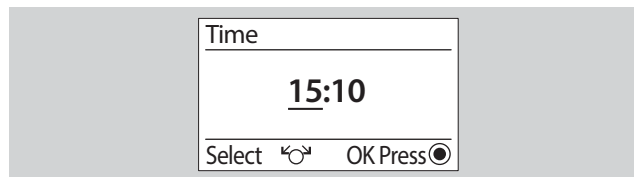

- ▷ Languages: German, English, French, Flemish, Spanish, Italian and Portuguese.
- 4 Select the language using the rotary knob.
  - 5 Press the OK button.
  - 6 To change other options, continue from step 2 or turn the selector switch back to  Automatic mode.

### Time



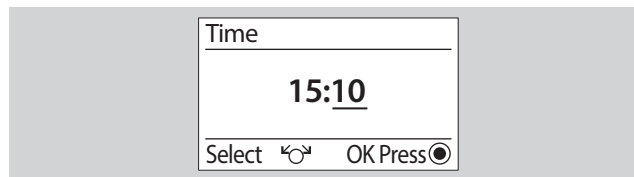

- ▷ Set the current time.
- 4 Use the rotary knob to set the hours.
  - 5 Press the OK button.

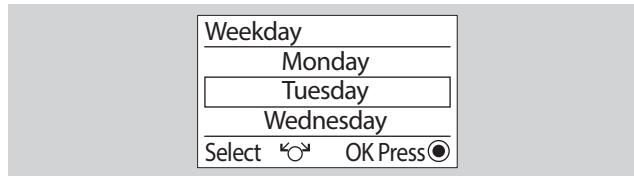

- 6 Use the rotary knob to set the minutes.
- 7 Press the OK button.
- 8 To change other options, continue from step 2 or turn the selector switch back to  Automatic mode.

## Weekday



- 4 Set the weekday using the rotary knob.
- 5 Press the OK button.
- 6 To change other options, continue from step 2 or turn the selector switch back to  Automatic mode.

## Reset

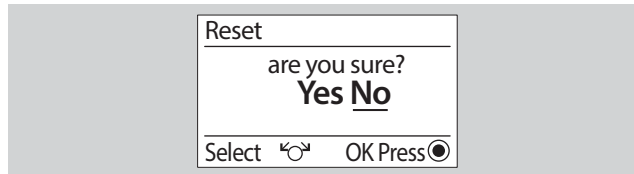

- ▷ The personal settings for time (parameter 01) and weekday (parameter 02) are retained, all other settings are deleted.
- 4 Note the personal settings in this manual.
  - 5 Select "Yes" using the rotary knob.
- ▷ If the settings are not to be changed, press the Back button or select "No" with the rotary knob.
- 6 Press the OK button.
- ▷ The factory settings have been loaded.
- 6 To change other options, continue from step 2 or turn the selector switch back to  Automatic mode.

## Parameter

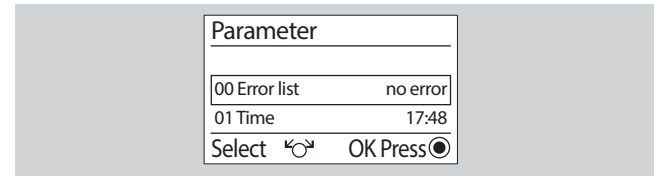

- 4 Select the desired parameter using the rotary knob, see page 14 (User – Parameters).
- 5 Press the OK button.
- 6 Use the rotary knob to set the desired value.
- 7 Press the OK button to confirm.
  - ▷ Parameters 00 (error list), 03 (day's production) and 04 (total production) are only displayed. They can be reset by pressing the OK button.
- 8 To change other parameters, continue from step 4.
- 9 To change other options (**Language, Time, Weekday or Reset**), continue with step 2 or turn the selector switch back to  Automatic mode.

### User – Commissioning



- 1** To commission the system, turn the selector switch to  Automatic mode.
  - ▷ The currently selected installation scheme with actuators and sensors is displayed.
- 2** With the rotary knob, select whether the designations (e.g. F1, F2, A1) or the momentary statuses and temperatures are displayed at the actuators and sensors.

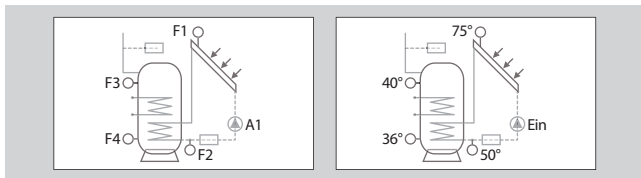

### User – Parameters

#### List of parameters P01 to P11

P No.	Parameter	Setting range	Factory setting	Own values
00	Error list	Display only	No error	
01	Time	00:00–24:00	00:00	
02	Weekday	Monday – Sunday	Monday	
03	Day's production	Display only	0.0 Wh	
04	Total production	Display only	0.0 Wh	
05	Pump Kick ON Time	OFF: 00:15–23:45	07:00	
06	Pump Kick OFF Time	00:15–24:00	22:00	
07	Reheating ON Time	OFF: 00:15–23:45	05:00	
08	Reheating OFF Time	00:15–24:00	21:00	
09	Cir. pump ON time	OFF: 00:15–23:45	05:00	
10	Cir. pump OFF time	00:15–24:00	21:00	
11	Antilegion start	00:00–23:45	02:00	

#### Explanation of the parameters

##### P00 Error list

In the event of faults, the corresponding errors with their corresponding numbers are shown on the display, see page 50 (Troubleshooting)

##### P01 Time

Shows the set time. Before commissioning of the controller or after a prolonged power failure, set the current time using this parameter.

---

**P02 Weekday**

Shows the list with the weekdays Monday to Sunday. Before commissioning of the controller or after a prolonged power failure, set the current weekday using this parameter.

---

**P03 Day's production**

Shows the day's production in Wh or kWh. Is automatically reset to 00:00 every day at 0000. The day's production can be reset manually by pressing the OK button (query: Are you sure? Yes No). The day's production is automatically added to the total production at the end of the day.

---

**P04 Total production**

Shows the total production in Wh or kWh. Is automatically incremented by the day's production every day at 00:00 h. The total production can be reset manually by holding the OK button pressed for  $\geq 2$  s.

---

**P05 Pump Kick ON Time/****P06 Pump Kick OFF Time**

It is possible that the collector sensor does not measure the real collector temperature (e.g. if it is partly in the shade). Briefly switching on the collector pump (pump kick) transports the heat transfer medium in the collector past the collector sensor in order to measure the rear collector temperature.

The pump kick function can be switched ON and OFF with the parameters 05 and 06 during the period in which solar production is expected.

P05 = OFF: The function is deactivated.

P05 = 00:00 to 23:45: Starting time of the pump kick function.

P06 = 00:15 to 23:45: Stopping time of the pump kick function.

---

**P07 Reheating ON Time/****P08 Reheating OFF Time**

If the collector does not generate sufficient heat, additional heat can be supplied to the storage tank by means of a further heat source. These parameters allow the function to be activated and the operating period to be set.

P07 = OFF: The function is deactivated.

P07 = 00:00 to 23:45: Reheating starting time,

P08 = 00:15 to 23:45: Reheating stopping time.

---

**P09 Circulation pump ON time****P10 Circulation pump OFF time**

The circulation pump in a water circuit ensures a fast supply of hot water to the tapping point. In order to avoid heat losses, the circulation pump should only run during periods when hot water is expected to be needed.

These parameters allow the function to be activated and the operating period to be set.

P09 = OFF: The function is deactivated.

P09 = 00:00 to 23:45: Circulation pump starting time.

P10 = 00:15 to 23:45: Circulation pump stopping time.

---

**P11 Antilegion start**

Time at which every Saturday the hot water tank and, where a circulation pump is used, also the pipework are heated to the value defined by parameter 53 (50 to 70 °C) as protection against thermoresistant bacteria.

P11 = 00:00 to 23:45.

### Technician - Installation

#### ! CAUTION

The minimum distance from surrounding heat sources is to be chosen so that the permitted ambient temperature will not be exceeded during operation, see page 50 (Technical Specifications).

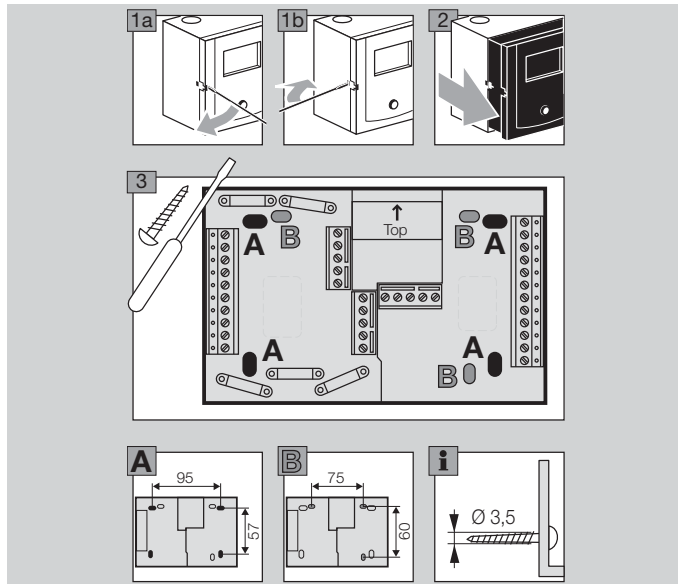

### Technician - Electrical connections

#### ⚠ WARNING

Possible life-endangering electrical shock! Switch the power off to electrical cables before working on power-carrying parts!

#### ! CAUTION

For fixed devices, an isolating mechanism must be installed for shutting off from the network, in accordance with the installation guidelines and EN 60335-1 or EN 60730-1, e.g. with a switch. The insulation for line conductors is to be protected against damage by overheating, e.g. insulating sleeve.

#### Define application

The differential controller for use with flat and tubular collectors, and for solid fuel boilers and layer storage systems, can be used to control the hydraulic systems from page 17 (System schemes). The application is determined automatically by connecting certain sensors on setting specific parameters.



## System schemes

With respect to the system schemes, please note that the respective control functions may be superposed by protection functions. An active collector protection function (P45) or storage tank recooling (P46) can therefore also trigger collector pump operation, see page 40 (P45 Collector safety temperature) and 40 (P46 Storage tank recooling switching threshold).

### Key

 F1 Sensor F1

 Heat exchanger

 A1 Pump A1

 Switch-over valve

 Solid fuel boiler

 Storage tank

 Collector

 Pulse generator (e.g. volume flow counter)

P30 Parameter 30

TempF1 Temperature at sensor 1

 Input and output of safety power circuit

 Input and output 24 V=

## System 1 (1 collector, 1 buffer storage tank)

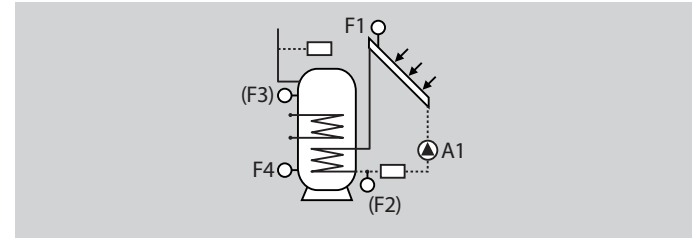

### Outputs

A1 Collector pump

Optional

A2 Additional relay, function can be freely assigned

A3 Additional relay, function can be freely assigned

### Inputs

F1 Collector sensor

F4 Tank bottom sensor

Optional

F2 Return sensor for heat volume metering

F3 Tank top sensor

F5 Additional sensor

### Switching conditions A1

ON:  $\text{Temp}_{F1} - \text{Temp}_{F4} > P30$  and  $\text{Temp}_{F1} > P40$ ,

OFF:  $\text{Temp}_{F1} - \text{Temp}_{F4} < P31$  or  $\text{Temp}_{F1} < P41$ .

## Technician - Electrical connections

### System 2 (1 solid fuel boiler, 1 storage tank or 1 solid fuel boiler, 2 storage tanks with switch-over valve)

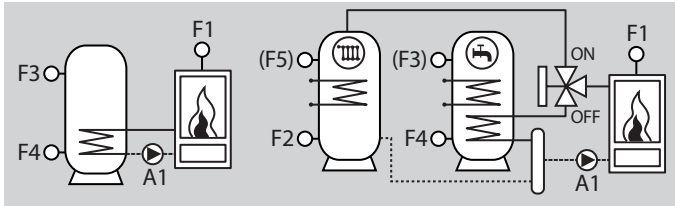

#### Outputs

A1	Feeding pump for solid fuel boiler
A2	Switch-over valve to storage tank 2 (if F2 is installed) or additional relay, function can be freely assigned
A3	Additional relay, function can be freely assigned

#### Inputs

F1	Solid fuel boiler sensor
F4	Tank bottom sensor
Optional	
F2	Tank bottom 2 sensor
F3	Tank top 1 sensor
F5	Tank top 2 sensor

#### Switching conditions A1

ON:	$\text{Temp}_{F1} - \text{Temp}_{F4} > P30$ and $\text{Temp}_{F1} > P43 + 5 \text{ K}$ or $\text{Temp}_{F1} - \text{Temp}_{F2} > P32$ and $\text{Temp}_{F1} > P43 + 5 \text{ K}$ ,
OFF:	$\text{Temp}_{F1} - \text{Temp}_{F4} < P31$ and $\text{Temp}_{F1} - \text{Temp}_{F2} < P33$ or $\text{Temp}_{F1} < P43$ .

#### Switching conditions A2

ON:	A1 = ON and $\text{Temp}_{F3} (\text{Temp}_{F4}) > P50$ or $\text{Temp}_{F1} - \text{Temp}_{F4} < P31$
OFF:	A1 = OFF or $\text{Temp}_{F3} (\text{Temp}_{F4}) < P50 - 5 \text{ K}$ or $\text{Temp}_{F1} - \text{Temp}_{F4} > P30$ .

**System 3 (1 collector, 1 storage tank, 1 solid fuel boiler)**

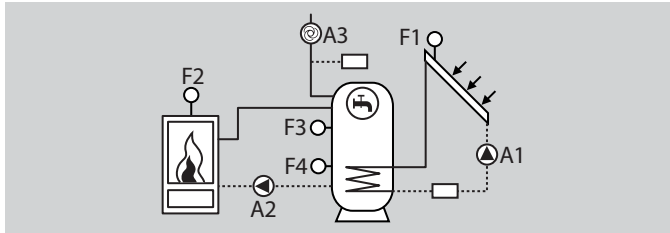

**Outputs**

A1	Collector pump (speed control)
A2	Feeding pump for solid fuel boiler
A3	Additional relay, function can be freely assigned

**Inputs**

F1	Collector sensor
F2	Solid fuel boiler sensor
F4	Tank bottom sensor or max. temperature monitoring A1 (if F3 is not installed)
Optional	
F3	Tank top sensor, Max. temperature monitoring A1 or reference sensor for reheating
F5	Additional sensor

**Switching conditions A1**

ON:  $Temp_{F1} - Temp_{F4} > P30$  and  $Temp_{F1} > P40$ ,  
 OFF:  $Temp_{F1} - Temp_{F4} < P31$  or  $Temp_{F1} < P41$ .

**Switching conditions A2**

ON:  $Temp_{F2} - Temp_{F4} > P32$  and  $Temp_{F2} > P43 + 5 K$ ,  
 OFF:  $Temp_{F2} - Temp_{F4} < P33$  or  $Temp_{F2} < P43$ .

**System 4 (2 collectors, 1 storage tank, 2 collector pumps)**

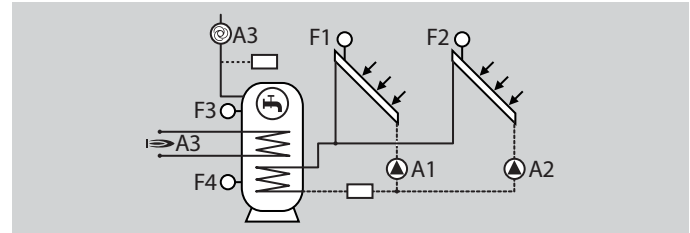

**Outputs**

A1	Collector pump 1
A2	Collector pump 2
Optional	
A3	Additional relay, function can be freely assigned

**Inputs**

F1	Collector 1 sensor
F2	Collector 2 sensor
F4	Tank bottom sensor
Optional	
F3	Tank top sensor
F5	Additional sensor

**Switching conditions A1**

ON:  $Temp_{F1} - Temp_{F4} > P30$  and  $Temp_{F1} > P40$ ,  
 OFF:  $Temp_{F1} - Temp_{F4} < P31$  or  $Temp_{F1} < P41$ .

**Switching conditions A2**

ON:  $Temp_{F2} - Temp_{F4} > P32$  and  $Temp_{F2} > P40$ ,  
 OFF:  $Temp_{F2} - Temp_{F4} < P33$  or  $Temp_{F2} < P41$ .

## Technician - Electrical connections

### System 5 (1 collector, 2 storage tanks, 1 switch-over valve)

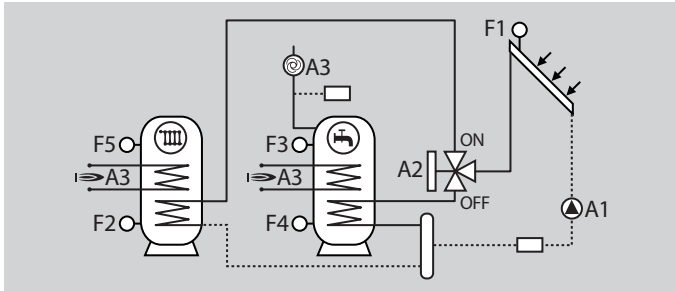

#### Outputs

A1	Collector pump
A2	Switch-over valve to storage tank 2
Optional	
A3	Additional relay, function can be freely assigned

#### Inputs

F1	Collector 1 sensor
F2	Tank bottom 2 sensor
F4	Tank bottom 1 sensor
Optional	
F3	Tank top 1 sensor
F5	Tank top 2 sensor

#### Switching conditions A1

- ON:  $\text{Temp}_{F1} - \text{Temp}_{F4} > P30$  or  $\text{Temp}_{F1} - \text{Temp}_{F2} > P32$   
and  $\text{Temp}_{F1} > P40$ ,
- OFF:  $\text{Temp}_{F1} - \text{Temp}_{F4} < P31$  and  $\text{Temp}_{F1} - \text{Temp}_{F2} < P33$   
or  $\text{Temp}_{F1} < P41$ .

#### Switching conditions A2

- ON:  $A1 = \text{ON}$   
and  $\text{Temp}_{F3}$  ( $\text{Temp}_{F4}$ , if F3 is not connected)  $> P50$   
or  $\text{Temp}_{F1} - \text{Temp}_{F4} < P31$
- OFF:  $A1 = \text{OFF}$   
or  $\text{Temp}_{F3}$  ( $\text{Temp}_{F4}$ , if F3 is not connected)  $< P50 - 5 \text{ K}$ ,  
or  $\text{Temp}_{F1} - \text{Temp}_{F4} > P30$

**System 6 (1 collector, 2 storage tanks, 2 charge pumps)**

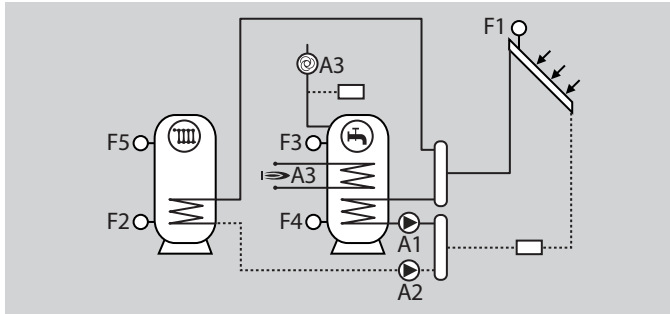

**Outputs**

A1	Charge pump for storage tank 1
A2	Charge pump for storage tank 2
Optional	
A3	Additional relay, function can be freely assigned

**Inputs**

F1	Collector 1 sensor
F2	Tank bottom 2 sensor
F4	Tank bottom 1 sensor
Optional	
F3	Tank top 1 sensor
F5	Tank top 2 sensor

**Switching conditions A1**

ON:  $Temp_{F1} - Temp_{F4} > P30$  and  $Temp_{F1} > P40$ ,  
 OFF:  $Temp_{F1} - Temp_{F4} < P31$  and  $Temp_{F1} < P41$ .

**Switching conditions A2**

ON: A1 = OFF  
 and  $Temp_{F1} - Temp_{F2} > P32$  and  $Temp_{F1} > P40$   
 OFF: A1 = ON  
 or  $Temp_{F1} - Temp_{F2} < P33$  or  $Temp_{F1} < P41$

## Technician - Electrical connections

### System 7 (1 collector, 1 storage tank or 2 storage tanks)

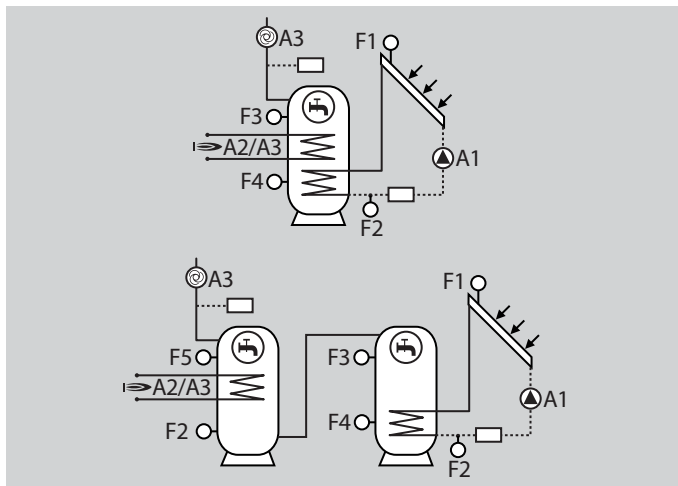

#### Inputs

F5	Additional sensor
----	-------------------

#### Switching conditions A1

ON:  $\text{Temp}_{F1} - \text{Temp}_{F4} > P30$  and  $\text{Temp}_{F1} > P40$ ,

OFF:  $\text{Temp}_{F1} - \text{Temp}_{F4} < P31$  or  $\text{Temp}_{F1} < P41$ .

#### Outputs

A1	Collector pump
----	----------------

Optional

A2	Additional relay, function can be freely assigned
----	---

A3	Additional relay, function can be freely assigned
----	---

#### Inputs

F1	Collector sensor
----	------------------

F4	Tank bottom (storage tank 1) sensor or max. temperature monitoring A1 (if F3 is not installed)
----	---

Optional

F2	Return sensor for heat volume metering
----	--

F3	Tank top (storage tank 1) sensor
----	----------------------------------

F5	Max. temperature monitoring A1 or reference sensor for reheating
----	---

**System 8 (1 collector, 1 storage tank, return temperature increase)**

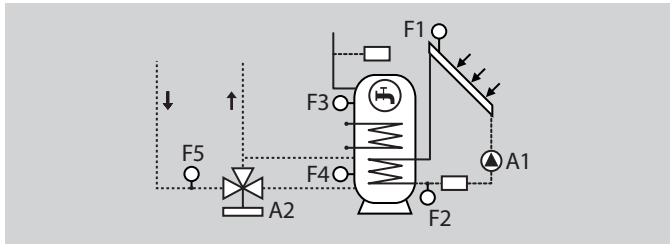

**Outputs**

A1	Collector pump
A2	Switch-over valve – heating return flow via storage tank
Optional	
A3	Additional relay, function can be freely assigned

**Inputs**

F1	Collector sensor
F4	Tank bottom sensor
F5	Return temperature increase sensor
Optional	
F2	Return sensor for heat volume metering
F4	Tank bottom sensor

**Switching conditions A1**

ON:  $Temp_{F1} - Temp_{F4} > P30$  and  $Temp_{F1} > P40$ ,  
 OFF:  $Temp_{F1} - Temp_{F4} < P31$  or  $Temp_{F1} < P41$ .

**Switching conditions A2**

ON:  $Temp_{F4} - Temp_{F5} > P32$ ,  
 OFF:  $Temp_{F4} - Temp_{F5} < P33$ .

**System 9 (1 solid fuel boiler, 1 storage tank, return temperature increase with mixer)**

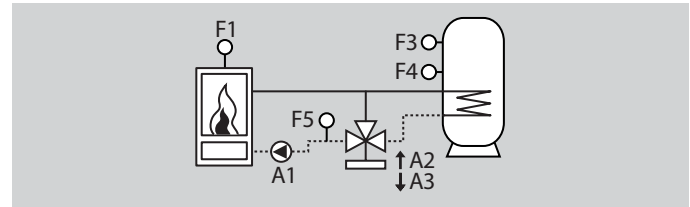

**Outputs**

A1	Feeding pump for solid fuel boiler
A2	Return temperature increase mixer OPEN
A3	Return temperature increase mixer CLOSED

**Inputs**

F1	Solid fuel boiler
F4	Tank bottom sensor
F5	Return temperature increase sensor
Optional	
F2	Additional sensor
F4	Tank top sensor

**Switching conditions A1**

ON:  $Temp_{F1} - Temp_{F4} > P30$  and  $Temp_{F1} > P43 + 5 K$ ,  
 OFF:  $Temp_{F1} - Temp_{F4} < P31$  or  $Temp_{F1} < P43$ .

**Switching conditions A2**

OPEN: Clocked according to mixer control at  $Temp_{F5} > P57 + 1 K$ .

**Switching conditions A3**

CLOSED: Clocked according to mixer control at  $Temp_{F5} < P57 - 1 K$ .

### System 10 (1 collector, 2 storage tanks, refeeding pump)

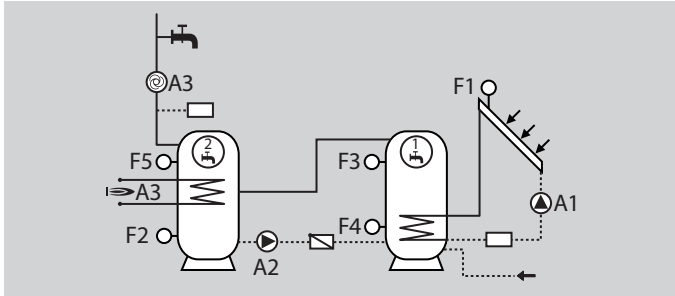

#### Outputs

A1	Collector pump
A2	Refeeding pump on storage tank 2
A3	Additional relay, function can be freely assigned

#### Inputs

F1	Collector sensor
F2	Tank bottom 2 sensor
F3	Tank top 1 sensor
F4	Tank top 1 sensor
Optional	
F5	Tank top 2 sensor

#### Switching conditions A1

ON:  $Temp_{F1} - Temp_{F4} > P30$  and  $Temp_{F1} > P40$ ,  
 OFF:  $Temp_{F1} - Temp_{F4} < P31$  or  $Temp_{F1} < P41$ .

#### Switching conditions A2

ON:  $Temp_{F3} - Temp_{F2} \geq P33$  and  $Temp_{F5} (Temp_{F2}) \leq P51 - 5 K$ ,  
 OFF:  $Temp_{F3} - Temp_{F2} < P33$  or  $Temp_{F5} (Temp_{F2}) > P51$ .

### System 11 (1 collector, 1 storage tank, 2 feeding areas)

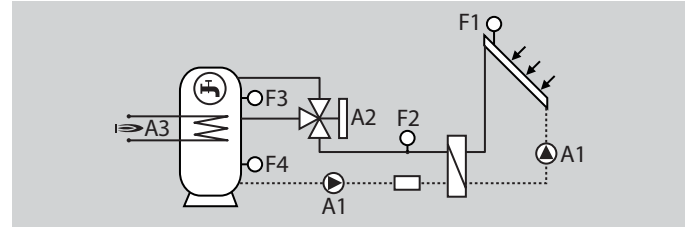

#### Outputs

A1	Collector pump
A2	Switch-over valve – central feeding area
A3	Additional relay, function can be freely assigned

#### Inputs

F1	Collector sensor
F3	Tank bottom sensor
F4	Tank top sensor
Optional	
F2	Return sensor for heat volume metering
F5	Additional sensor

#### Switching conditions A1

ON:  $Temp_{F1} - Temp_{F4} > P30$  and  $Temp_{F1} > P40$ ,  
 OFF:  $Temp_{F1} - Temp_{F4} < P31$  or  $Temp_{F1} < P41$ .

#### Switching conditions A2

ON: A1 = ON  
 and  $Temp_{F2} - Temp_{F3} > P32$  and  $Temp_{F3} < P50 - P32$ ,  
 OFF: A1 = OFF  
 or  $Temp_{F2} - Temp_{F3} < P33$  or  $Temp_{F3} > P50 - P33$ .



**System 12 (1 collector, 1 storage tank, 3 feeding areas)**

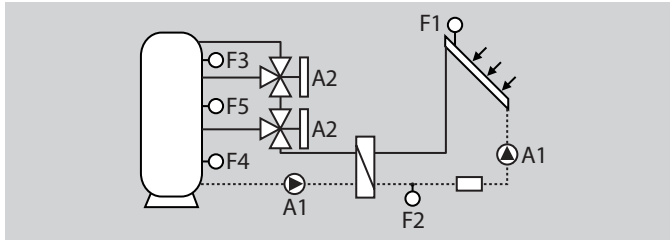

**Outputs**

A1	Collector pump and storage tank feeding pump
A2	Switch-over valve – lower feeding area
A3	Switch-over valve – central feeding area

**Inputs**

F1	Collector sensor
F3	Tank top sensor
F4	Tank bottom sensor
F5	Tank centre sensor
Optional	
F2	Return sensor for heat volume metering

**Switching conditions A1**

ON:  $Temp_{F1} - Temp_{F4} > P30$  and  $Temp_{F1} > P40$ ,  
 OFF:  $Temp_{F1} - Temp_{F4} < P31$  or  $Temp_{F1} < P41$ .

**Switching conditions A2**

ON: A1 = ON  
 and  $Temp_{F1} - Temp_{F5} > P32$  and  $Temp_{F5} < P50 - P32$ ,  
 OFF: A1 = OFF  
 or  $Temp_{F1} - Temp_{F5} < P33$  or  $Temp_{F5} > P50 - P33$ .

**Switching conditions A3**

ON: A1 = ON  
 and  $Temp_{F1} - Temp_{F3} > P32$  and  $Temp_{F3} < P50 - P32$ ,  
 OFF: A1 = OFF  
 or  $Temp_{F1} - Temp_{F3} < P33$  or  $Temp_{F3} > P50 - P33$ .

## Technician - Electrical connections

### System 13 (1 collector, 1 storage tank, drain-back system)

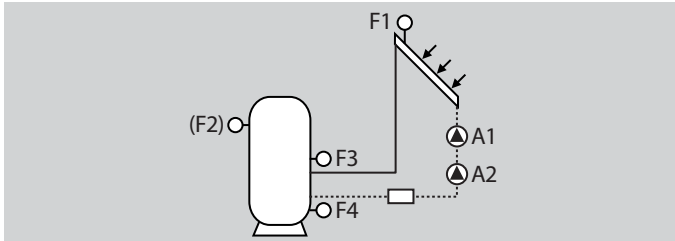

#### Outputs

A1	Collector pump 1
A2	Collector pump 2 for system filling

#### Inputs

F1	Collector sensor
F3	Storage tank inlet sensor
F4	Storage tank outlet sensor
Optional	
F2	Tank top sensor
F5	Additional sensor

#### Switching conditions A1 and A2

ON:  $\text{Temp}_{F1} - \text{Temp}_{F4} > P30$  and  $\text{Temp}_{F1} > P40$   
and  $\text{Temp}_{F1} < P42$   
and  $\text{Temp}_{F4} < P84$

OFF:  $\text{Temp}_{F2} > P50$ .

- ▷ In order to fill the collector, the pumps (A1, A2) are switched on together for the time set with P87. During filling, the pumps run at the speed set with P107.

#### Switching conditions A1

At the end of the time set with P87:

ON: Control enable collector pump A1.  
OFF:  $\text{Temp}_{F3} - \text{Temp}_{F4} < P31$   
or  $\text{Temp}_{F3} > P85$   
or  $\text{Temp}_{F4} > P86$ .

#### Switching conditions A2

OFF: At the end of the time set with P87.

- ▷ Due to the drain-back function, no safety functions (frost protection, max. collector temperature) are active during standby.



### Special functions

Depending on the system selected, the outlets A2 and A3 can be assigned to special functions. The desired function is set with P54 separately for A2 and A3.

#### Circulation pump

A circulation pump can be activated with parameter P54 = 1, P54 = 2 or P54 = 3.

P54 = 1: The circulation pump is switched on permanently during the enable times (P09 Cir. pump ON time/P10 Cir. pump OFF time).

P54 = 2: If there is a short-circuit at the impulse inlet, the circulation pump gets switched on for the set switching duration P55. The pump can be switched on again only after the set reclose blocking period P56 has elapsed. It is switched on only during the enable times (P09 Cir. pump ON time/P10 Cir. pump OFF time).

P54 = 3: Activation with active Hot water short heating (P53)

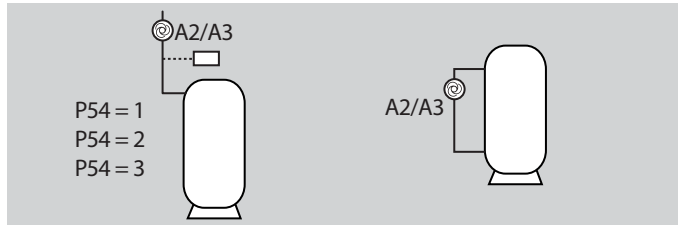

### Reheating

The reheating function, e.g. using an electric immersion heater, can be activated using parameter P54 = 4 (storage tank 1) or P54 = 5 (storage tank 2).

The additional heat source is activated when the storage tank temperature at F3 on storage tank 1 (F5 on storage tank 2) drops below the desired temperature (P47) by (P34).

> Desired temperature with solar production = (P47- P52).

The heat source is switched off again when the temperature of the storage tank exceeds the desired temperature.

This function is active during the enable time (P07 Reheating ON Time/P08 Reheating OFF Time).

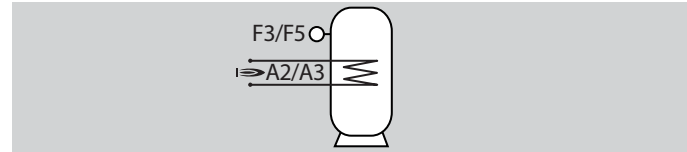

### Return temperature increase

The return temperature increase function can be activated with parameter P54 = 6 (storage tank 1; F4) or P54 = 7 (storage tank 2; F2). The return flow of the heating system is passed through the storage tank and is heated by it. The system is switched on via A2 when the temperature in the storage tank has exceeded the temperature of the return flow (F5) by the switch-on threshold (P32).

The return temperature increase is switched off when the temperature in the storage tank (F2/F4) drops below the temperature of the return flow (F5) and the switch-off threshold (P33) (F2/F4 = F5 - P33).

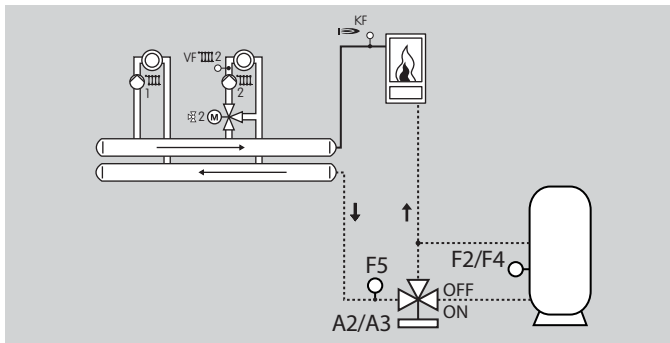

## Connection diagram controller in socket

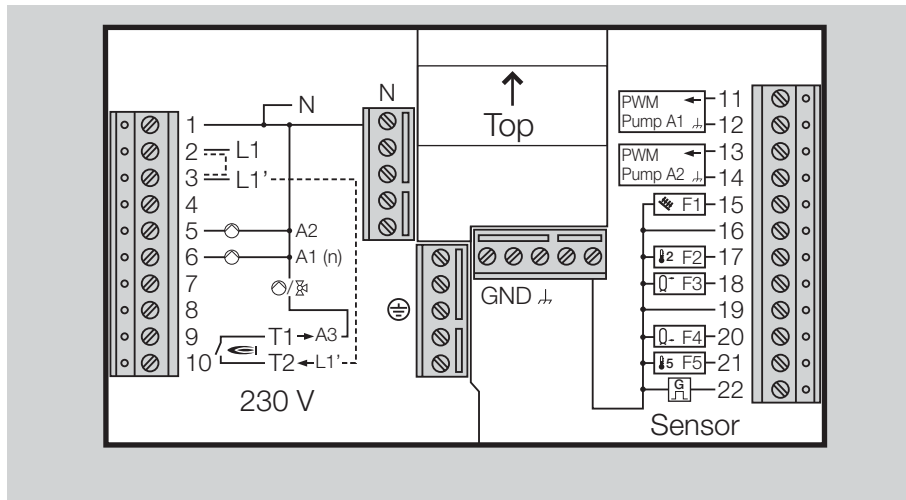

~230 V, relay switching capacity 2(2) A, ~250 V	
1	Neutral conductor mains
2	Mains voltage heating controller L1
3	Mains voltage for the outputs L1'
5	Pump A2, variable-speed
6	Pump A1, variable-speed
9-10	Relay, floating

SELV, safety extra low voltage	
11-12	Speed of pump A1
13-14	Speed of pump A2
15	Sensor F1
16	Earth for sensor connections
17	Sensor F2
18	Sensor F3
19	Earth for sensor connections
20	Sensor F4
21	Sensor F5
22	Pulse generator

- ▷ Provided no separate regulations for protecting the relay apply, a bridge to supply the relays for pump A1 and A2 must be connected between terminals 2 and 3.

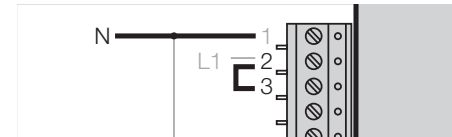

- ▷ A bridge must be connected terminals 3 and 10 if a connected actuator is operated via the floating relay.

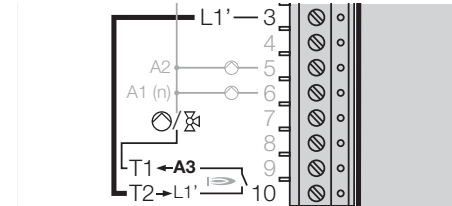

- ▷ Use fixed cables or flexible cables with wire end sleeves for connections (230 V). Connection to the CAN bus is not possible.
- ▷ Collector sensor (F1): Use only KLF 1000, see page 48 (Accessories).
- ▷ Connect only sensors necessary for the installation.

Connection RDS2/EKSRDS2A

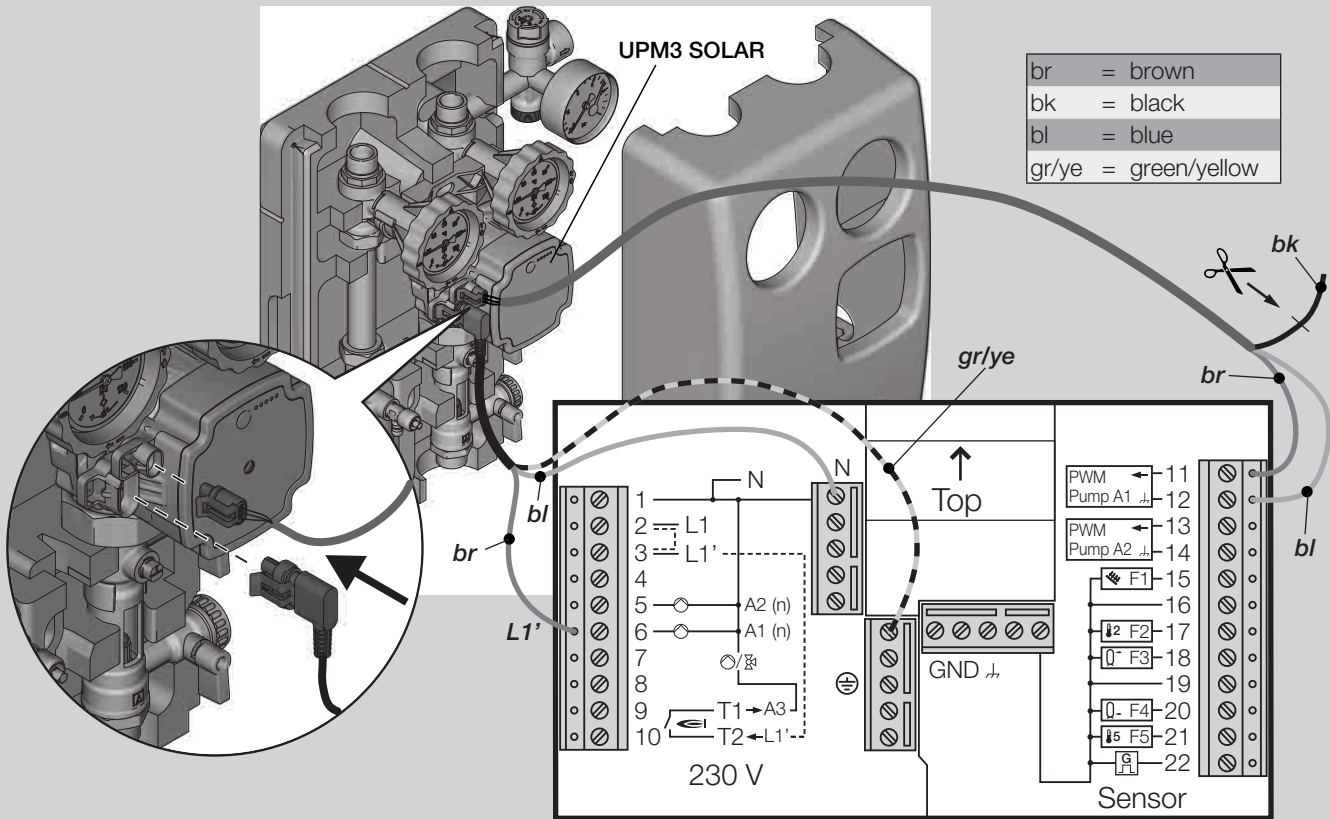

### Technician – Settings

#### **WARNING**

Incorrect settings can cause malfunctions and damage the heating installation! Only a qualified technician may change the parameters from no. 21.

- 1 Turn selector switch to  "Technician Setting".

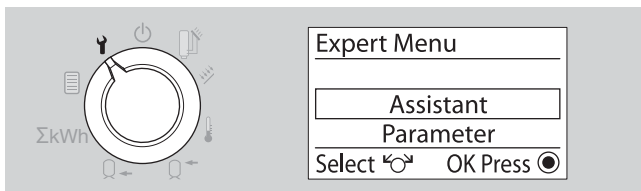



- ▷ The display shows the options with which the heating system can be set.
- 2 Select the desired option (**Assistant, Parameter, Relaireset** or **Reset**) using the rotary knob.
  - 3 Press the OK button.

#### **Assistant** (system installation)

- ▷ The assistant allows the heating installation to be comfortably installed by selecting the number of connected sensors and actuators.
  - ▷ Alternatively, an appropriate system scheme can be selected with parameter 22, see page 37 (P22 Select system) .
  - ▷ A code number has to be entered before settings can be changed (factory setting 0000).
- 4 Enter the code number.

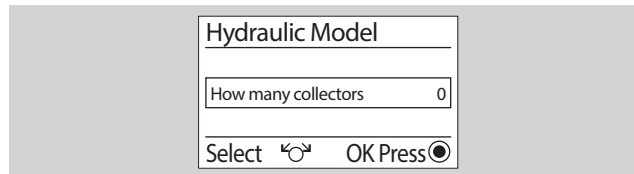
- ▷ The display shows "wrong code" if the code number is not entered correctly. Repeat step 4 with the right code number.
- 5 Press the OK button.
- ▷ On the display, the input of the number of collectors is prompted.



- 6 Alter the number (0, 1 or 2), if necessary, using the rotary knob.
  - 7 Press the OK button.
  - 8 Then alter the number of connected storage tanks, mixers, solid fuel boilers, pumps and valves and confirm with the OK button.
- ▷ The display shows the system scheme and installation number (top left).
  - ▷ If several system schemes are displayed, they can be selected using the rotary knob, see page 17 (System schemes)
- 9 Press the OK button.
- ▷ The display shows "Wait for Restart" and then the software number (405.Exx).
  - ▷ Further settings can be made in the Expert menu.
  - ▷ To commission the system, turn the selector switch back to  Automatic mode.



## Parameters

- ▷ Parameters P1 to P11 for users, see page 14 (User – Parameters).

### Change Code no.

- ▷ In order to be able to change settings above parameter 22, a code number has to be defined with parameter P21 (factory setting 0000).
- ▷ If necessary, turn the rotary knob until "21 Code no." appears on the display.

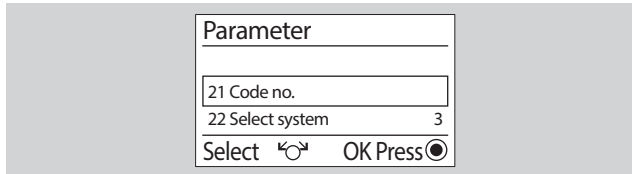

- 4** Press the OK button.
- ▷ Display shows 0000.

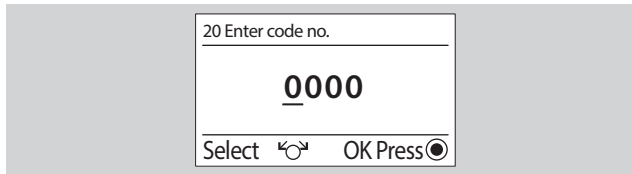



- 5** To enter the "old" code number, set each digit with the rotary knob and press the OK button.
- ▷ The display shows "wrong code" if the code number is not entered correctly. Repeat step **4** with the right code number.
- 6** Then to enter the "new" code number, set each digit with the rotary knob and press the OK button.

- 7** Note the "new" code number.
- ▷ **From now on, the "new" code number always has to be entered in order to change settings as well as to reset the controller (Reset).**
- ▷ **To reset the code number to the factory setting (0000), press and hold the OK button and connect the power supply to the controller. This will reset the device to its factory setting.**

### Set parameters

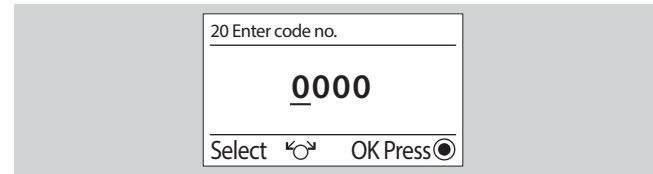
- 4** Select the desired parameter using the rotary knob.
- ▷ A number of parameters can only be displayed.
- 5** Press the OK button.
- ▷ Display shows 0000.



- 6** To enter the code number, select each digit with the rotary knob and press the OK button.
- 7** Set the selected parameter using the rotary knob.
- 8** Press the OK button to confirm.
- ▷ Continue from step **4** if further parameters are to be set. (The code number does not have to be entered again).
- ▷ To commission the system, turn the selector switch back to  Automatic mode.
- ▷ The table on page 36 (List of parameters P21 to P110) shows the setting possibilities.

### Relaistest (Relay test)

- ▷ The relay test allows connected actuators (pumps, switch-over valves) to be actuated individually to check their function.
- 4** To start the test, enter the code number (factory setting 0000).
- ▷ The display shows "wrong code" if the code number is not entered correctly. Repeat step **4** with the right code number.
- 5** Press the OK button.

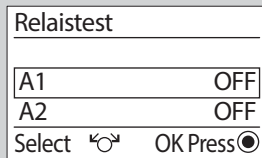

Relaistest	
A1	OFF
A2	OFF
Select	↶ OK Press ●

- 4** Select the relay (A1, A2 or A3) with the rotary knob.
- 5** Press the OK button to switch the relay on or off.
- 8** Press the Back button (Esc) to end the test.
- ▷ Turn the selector switch back to  Automatic mode.

### Reset

- ▷ The personal settings (parameters 01 to 11) are retained, all the other parameters are reset to the factory setting.
- 4** Note the personal settings in this manual.
- 5** To start the test, enter the code number (factory setting 0000).
- ▷ The display shows "wrong code" if the code number is not entered correctly. Repeat step **5** with the right code number.
- ▷ **If the code number is not known and to reset the code number, hold the OK button pressed and connect the power supply to the controller.**
- 6** Press the OK button.

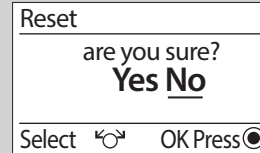

Reset	
are you sure?	
<b>Yes No</b>	
Select	↶ OK Press ●

- 7** Select "Yes" using the rotary knob.
- ▷ If the settings are not to be changed, press the Back button (Esc) or select "No" with the rotary knob and press the OK button.
- ▷ The factory settings are loaded.
- ▷ For commissioning, modify the settings if necessary and turn the selector switch back to  Automatic mode.



### Technician – Parameters

#### List of parameters P21 to P110

P No.	Parameter	Setting range	Factory setting	Own values
21	Code no.	0000 to 9999	0000	
22	Select system	1 to 13	1	

#### Speed control A1/A2

23	Speed level value	Display only		
24	Op. mode speed cntrl	Auto; Manual	Auto	
25	Speed level (Manual)	30% to 100%	100%	
26	Min. Speed level (Auto)	30% to 100%	30%	
27	Max. Speed level (Auto)	30% to 100%	100%	
28	Diff. temp., 100% cntrl	10 K to 50 K	35 K	

#### ON/OFF switching differences, hysteresis

30	On switching diff.1	1 K to 30 K	6 K	
31	Off switching diff.1	1 K to 30 K	3 K	
32	On switching diff.2	1 K to 30 K	6 K	
33	Off switching diff.2	1 K to 30 K	3 K	
34	Hysteresis reheating	1 K to 30 K	5 K	

#### Special functions

40	En. temp., collector(s)	-20°C to +95°C	40°C	
41	Dis. temp., collector(s)	-20°C to +95°C	35°C	
42	Max. coll. temp.	80°C to 180°C	110°C	
43	En. temp. 2nd heat gen.	0°C to 90°C	60°C	
44	Max. boiler temp.	30°C to 130°C	90°C	
45	Collector safety temp.	80°C to 180°C	110°C	
46	Threshld, tank Recooling	OFF; 1 K to 30 K	OFF	

P No.	Parameter	Setting range	Factory setting	Own values
47	Set temp., tank (reheat)	10°C to 90°C	40°C	
50	Max tank temp., tank1	10 °C to 130 °C	60°C	
51	Max tank temp., tank2	10 °C to 130 °C	60°C	
52	Tol. during solar prod.	0 K to 90 K	10 K	
53	Hot water short heating	OFF, 50°C to 70°C	OFF	

#### Functions of additional relays A2 and A3

54	Function A2 and/or Function A3	0 to 8	0	
55	Cir. pump on time	1 min to 10 min	1 min	
56	Cir. pump blocking	1 min to 20 min	5 min	

#### Return temperature increase

57	Min. return flow temp.	0°C to 90°C	60°C	
58	Mixer dynamic Open	5 K to 25 K	18 K	
59	Mixer dynamic Close	5 K to 25 K	12 K	

#### Pump kick function (temperature test function)

60	Kick duration	OFF; 2 sec to 59 sec	OFF	
61	Kick pause	10 min to 60 min	30 min	
62	Meas. time for 0.5K incr.	1 min to 5 min	1 min	
63	Frost protection temp.	OFF; -5°C to +5°C	OFF	

#### Production estimate/Volume flow counter

70	Pulse rate	0.0 to 100	1.1	
71	Pulse rate unit	ml/pulse; l/pulse	ml/pulse	
72	Vol. flow distribution	1:99 to 99:1	50:50	
75	Vol. flow - collector1	OFF; 0,1l/min to 100 l/min	OFF	

P No.	Parameter	Setting range	Factory setting	Own values
76	Vol. flow - collector2	OFF; 0.1l/min to 100 l/min	OFF	
78	Mixing ratio	0% to 70%	40%	
79	Glycol type	Propylene glycol; Ethylene glycol	Propylene glycol	

#### Drain back

84	Max tank output	50°C to 75°C	68°C	
85	Max tank input active	60°C to 110°C	95°C	
86	Max tank output active	60°C to 110°C	75°C	
87	Filling time	1 min to 10 min	3 min	

#### Software

99	Software no.	Display only		
----	--------------	--------------	--	--

#### Pump controller PWM-/0...10V

101	Speed control variant	PWM; 0...10 V	PWM	
102	PWM base frequency	180 Hz; 1 kHz; 2 kHz	180 Hz	
103	PWM ratio ON	0% to 100%	15%	
104	PWM ratio OFF	0% to 100%	0%	
105	PWM ratio Pmin	0% to 100%	15%	
106	PWM ratio Pmax	0% to 100%	100%	
107	PWM ratio Povrspeed	OFF; 0% to 100%	Off	
108	Voltage 0%	0 to 10 V	0V	
109	Voltage 100%	0 to 10 V	10 V	
110	Voltage OFF	0 to 10 V	0 V	

## Explanation of the parameters

### P21 Code No.

Here you can specify your own code number. Remember this code well! This code number is required to change parameters 22, 24 – 110 and to reset the controller.

- ▷ Factory setting = 0000.
- ▷ If the code number is not known and to reset the code number, hold the OK button pressed and connect the power supply to the controller.

Changing the code number, see pages 32 (Technician – Settings) and 33 (Change Code no.).

### P22 Select system

On selecting the system, the function of the device is redefined. Set the number of the system according to the connection descriptions for system 1 to system 13, see from page 17 (System schemes).

- ▷ After changing the Select system parameter, all settings except the selected language are reset to the factory settings (code number is reset to 0000).

### Speed control A1/A2

#### P23 Speed level value

Display of the actual value for the speed of pump A1 and pump A2 (if installed) in %.

- ▷ Display without input of the code number.

#### P24 Op. mode speed cntrl

P24 = 0: Automatic, the differential controller determines the speed for A1/A2.

P24 = 1: Manual, the speed set under P25 applies to A1/A2.

## Technician – Parameters

---

### **P25 Speed level (Manual)**

Function only if P24 = 1 is selected (Op. mode speed cntrl = Manual).  
P25 = 30–100%: Specifies the speed for pump A1.

---

### **P26 Min. Speed level (Auto)**

Function only if P24 = 0 is selected (Op. mode speed cntrl = Automatic).  
P26 = 30–100%: To define the minimum speed in % at which pump A1 is to run. Select the value such that the pump runs reliably at this speed (P26 < P27).

---

### **P27 Max. Speed level (Auto)**

Function only if P24 = 0 is selected (Op. mode speed cntrl = Automatic).  
P27 = 30–100%: To define the maximum speed in % at which pump A1 is to run. Select the value such that the pump runs reliably at this speed (P27 > P26).

---

### **P28 Temperature difference for 100% control**

Function only if P24 = 0 is selected (Op. mode speed cntrl = Automatic).  
P28 = 5–50 K: The pump is started at full speed [100%] for the temperature difference between collector 1 and the active storage tank that is set here. The pump is slowed down if the temperature difference is lower.

---

### **ON/OFF switching differences, hysteresis**

---

#### **P30 Switch-on threshold 1**

P30 = 1–30 K: The feeding function for storage tank 1 via pump A1 is enabled when the temperature difference between sensor F1 (collector/solid fuel) and sensor F4 (storage tank bottom) exceeds the switch-on threshold.

#### **P31 Switch-off threshold 1**

P31 = 1–30 K: The feeding function for storage tank 1 is barred when the temperature difference between sensor F1 (collector/solid fuel) and sensor F4 (storage tank bottom) drops below the switch-off threshold.

---

#### **P32 Switch-on threshold 2,**

#### **P33 Switch-off threshold 2**

P32, P33 = 1–30 K.

**Systems 1, 7, 9, 13:** No function.

**Systems 2, 5:** The feeding function for storage tank 2 via pump A1 is enabled when the temperature difference between sensor F1 (solid fuel/collector) and sensor F2 (storage tank 2) exceeds the switch-on threshold.

The feeding function for storage tank 2 is deactivated again when the difference drops below the set switch-off threshold.

The valve A2 is switched in the direction of storage tank 2 when the feeding function for storage tank 2 is enabled and storage tank 1 cannot be fed.

**Systems 3, 4:** The feeding function via pump A2 is enabled when the temperature difference between sensor F2 (solid fuel/ collector 2) and sensor F4 (storage tank bottom) exceeds the switch-on threshold.

**System 6:** The feeding function for storage tank 2 via pump A2 is enabled when the temperature difference between sensor F1 (collector) and sensor F2 (storage tank 2) exceeds the switch-on threshold. The feeding function for storage tank 2 is deactivated again when the difference drops below the set switch-off threshold.

**System 8:** see page 28 (Reheating)

**System 10:** The refeeding function via pump A2 is enabled when the temperature at sensor F3 (tank top 1) exceeds the temperature at sensor F2 (tank bottom 2) by the switch-on threshold (P32).

The refeeding function via pump A2 is deactivated again when the temperature at sensor F3 (tank top 1) drops below the temperature at sensor F2 (tank bottom 2) by the switch-off threshold (P33).

**System 11:** Valve A2 switches on when the temperature at sensor F1 (collector) exceeds the temperature at sensor F3 (storage tank top) by the switch-on threshold (P32).

Valve A2 switches off when the temperature at sensor F1 (collector) drops below the temperature at sensor F3 (storage tank top) by the switch-off threshold.

**System 12:** Valve A3 switches on when the temperature at sensor F1 (collector) exceeds the temperature at sensor F3 (storage tank top) by the switch-on threshold.

Valve A3 switches off when the temperature at sensor F1 (collector) drops below the temperature at sensor F3 (storage tank top) by the switch-off threshold (feeding into the middle or upper storage tank section).

Valve A2 switches on when the temperature at sensor F1 (collector) exceeds the temperature at sensor F5 (middle storage tank) by the switch-on threshold (feeding into the middle or upper storage tank section).

Valve A2 switches off when the temperature at sensor F1 (collector) drops below the temperature at sensor F5 (middle storage tank) by the switch-off threshold (feeding into the lower storage tank section).

### P34 Hysteresis reheating

P34 = 1–30 K: Reheating is activated when the set temperature drops below the hysteresis set here. Reheating is deactivated again when the set temperature set with P47 is exceeded.

## Special functions

### P40 Collector enable temperature,

### P41 Collector disable temperature

P40, P41 = -20–+95°C:

**Systems 2, 9:** No function

**System 1, 3, 4, 5, 6, 7, 8, 10, 11, 12:** The collector pump is enabled when the associated collector temperature exceeds the enable temperature. It is disabled when the collector temperature drops below the disable temperature. This function prevents the pump starting without relevant heat production.

**System 13:** Collector pumps A1 and A2 are enabled when the associated collector temperature exceeds the enable temperature. The collector pumps remain active for the filling time set with P87.

### P42 Maximum collector temperature

P42 = 80–180°C:

**Systems 2, 9:** No function

**Systems 1, 3, 4, 5, 6, 7, 8, 10, 11, 12, 13:** The collector pumps are deactivated when the associated collector temperature exceeds the safety limit set here (system protection).

The pumps are reactivated when the temperature drops below the maximum collector temperature – 10K.

### P43 Enable temperature 2nd heat gen. (solid fuel boiler)

P43 = 0–90°C:

**Systems 1, 4, 5, 6, 7, 8, 10, 11, 12, 13:** No function.

**Systems 2, 3, 9:** The corresponding pump is enabled when the temperature of the 2nd heat source (systems 2 and 9 = F1, system 3 = F2) exceeds the limit set here by 5K. It is disabled when the temperature of the heat source drops below the enable temperature.

## Technician – Parameters

---

This function ensures that the heat source can reach its operating temperature.

---

### **P44 Maximum boiler temperature (solid fuel boiler)**

P43 = 30–130°C:

**Systems 1, 4, 5, 6, 7, 8, 10, 11, 12, 13:** No function

**Systems 2, 3, 9:** The feeding pump of the solid fuel boiler is deactivated when the temperature of the boiler exceeds the limit temperature set here (system protection).

The pump is reactivated when the temperature falls 10 K below the limit value.

---

### **P45 Collector safety temperature**

P45 = 80–180°C:

**Systems 2, 9:** No function.

**Systems 1, 3, 4, 5, 6, 7, 8, 10, 11, 12:** The collector protection temperature protects the collector against overheating. It is activated when the set maximum collector temperature P42 is greater than the collector safety temperature P45 set here.

If the collector temperature F1 or F2 exceeds the set collector safety temperature P45 and the storage tank temperature is < 92°C, the storage tank is fed beyond its maximum temperature to 95°C to cool the collector. The function is interrupted when the collector exceeds its maximum temperature P42. The function is activated again when the collector temperature is P42 - 3 K.

---

### **P46 Storage tank recooling switching threshold**

P46 = OFF: No storage tank recooling

P46 = 0–30 K: Storage tank recooling is active. If the collector protection function has fed the storage tanks during the day to temperatures in excess of the set maximum storage tank temperatures P50, P51, then the storage tank can be automatically cooled to the

set maximum temperature of the storage tank P50, P51 at night between 1.00 and 6.00 h by switching on the feeding pumps. The storage tank cannot be fed during this period. This function is meant to protect the storage tank.

Recooling can take place only when the temperature of the storage tank exceeds the collector temperature by at least the value of switching threshold P46 + 3 K hysteresis.

---

### **P47 Reheating set temperature**

Only when special function Reheating is selected, see page 15 (P07 Reheating ON Time/ P08 Reheating OFF Time).

P47 = 10–90°C: An additional heat source (A2/A3) is enabled when the storage tank temperature at the upper cylinder sensor (F3/F5) drops below the set temperature set here by P34.

The heat source is disabled again when the temperature of the storage tank exceeds the enable temperature.

If there is solar production, the switching thresholds are moved down by the parameter P52: Enabling occurs at an upper storage tank temperature < P47-(P52+P34).

---

### **P50 Maximum storage tank temperature, tank 1**

P50 = 10–130°C: If a sensor (F3, storage tank top) is installed, it is used to monitor the maximum temperature. If this sensor is not installed, the maximum storage tank temperature is monitored by F4. In this case, the stratification of the tank must be taken into account.

**Systems 1, 3, 4, 7, 8, 9, 10, 11, 12, 13:** The feeding pumps are disabled when the temperature of storage heater 1 exceeds the safety limit temperature set here (system protection).

The pumps are enabled again when the temperature drops below the maximum storage tank temperature – 5 K.



**Systems 2, 5, 6:** For these systems it is also possible to additionally keep feeding storage tank 2.

---

**P51 Maximum storage tank temperature, tank 2**

P51 = 10–130°C

**Systems 1, 3, 4, 7, 8, 9, 11, 12, 13:** No function

**Systems 2, 5:** Feeding pump A1 is disabled when the temperature of storage heater 2 exceeds the maximum storage temperature set here and storage tank 1 cannot be fed (A2 = ON towards storage tank 2). The pump is enabled again when the temperature drops below the maximum storage tank temperature – 5 K.

**Systems 6, 10:** Feeding pump A2 is disabled when the temperature of the storage heater 2 exceeds the maximum storage temperature set here (system protection).

The pump is enabled again when the temperature drops below the maximum storage tank temperature – 5 K.

After 30 min, the feeding of storage heater 2 is interrupted for 2 min. If the collector temperature increases by at least 1 K during this time, feeding will continue to be interrupted for another 2 min. This is repeated until no further temperature increase is detected or the primary storage tank can be fed again.

---

**P52 Tolerance during solar production**

Can only be set when P54 = 4 or 5 (refeeding).

P52 = 0–90 K

**Systems 1, 2, 3, 4, 5, 6, 7, 8, 10, 11:** If the storage tank is fed from the collector/solid fuel boiler, the additional heat source is only enabled when the storage tank temperature drops below the set reheating temperature (P47) by the value Tolerance with solar production (P52) + Hysteresis reheating (P34). It is disabled again when the storage tank temperature reaches the value of set temperature P47 minus tolerance value.

---

**P53 Hot water short heating**

The hot water short heating can only be performed when an external heat source (reheating function) is able to generate the necessary temperatures and when the special function Reheating is selected, see page 15 (P07 Reheating ON Time/ P08 Reheating OFF Time).

P53 = OFF: No hot water short heating

P53 = 50 – 70 °C: Once every Saturday the storage tank is heated to the defined temperature value at the time set with P11 (Antilegion start) (= increase of the desired temperature). The antilegion function is only performed when the defined storage tank temperature was not reached during the previous week. The temperature is monitored by sensor F4 (storage tank bottom).

The hot water short heating is stopped when the set temperature cannot be reached within 3 hours or when the programmed maximum storage tank temperature (at least 65°C) is detected at sensor F3 (only when installed).

### Functions of additional relays A2 / A3

If outputs A2 and A3 are not specifically assigned by the system scheme, they can be assigned a freely selectable special function, see page 28 (Special functions).

---

#### P54 Function A2 and/or A3

P 54 = 0: Output A2/A3 not active

P 54 = 1: Circulation pump enable. The output is switched on permanently during the enable time of the circulation pump (P09 Circulation pump ON/P10 Circulation pump OFF).

P54 = 2: Circulation pump at pulse. If there is a short-circuit at the pulse input (terminal 22), the circulation pump is switched on for the set switching duration P55. The pump can be switched on again only after the set reclose blocking period P56 has elapsed. The set circulation program has priority. Switching on takes place only during the enable time (P09 to P10).

P54 = 3: Circulation pump during hot water short heating. The output is switched on during hot water short heating.

P54 = 4: Reheating storage tank 1, reference sensor F3

P54 = 5: Reheating storage tank 2, reference sensor F5

▷ The reheating function is active only during the enable times (P07 to P08). If the set temperature for the storage tank drops by at least 5 K (in case of solar production by P52+5 K) during this period, then the selected output switches on ( reheating) until the set temperature has been reached (reheating OFF). If there is heat input into the storage tank via solid fuel boiler/collector, the reheating function is activated only when the temperature drops below the tolerance limit (see page 41 (P52 Tolerance during solar production)).

P54 = 6: Return temperature increase storage tank 1

P54 = 7: Return temperature increase storage tank 2

P54 = 8: Fan/coil. The output is activated if the collector safety temperature (P45) is exceeded. When the storage tank is full, the excess heat is dissipated via a heat exchanger with fan (fan/coil) to prevent collector pump A1 switching off.

---

#### P55 Circulation pump on time

P55 = 1–10 min

Running time of the circulation pump after a pulse is received (start of water tapping) at terminal 22.

---

#### P56 Circulation pump blocking

P55 = 1–20 min

If the circulation pump is switched on, it can be started again only after the reclose blocking time has elapsed.

#### Return temperature increase

See also page 28 (Reheating)

**System 9:** The built-in mixer (A2=OPEN, A3=CLOSED) regulates the return flow temperature of the heat source to the set minimum return flow temperature (P57). If this temperature is not reached in the heat source, the mixer is closed completely. If the return flow temperature (F5) from the storage tank increases beyond this value, the mixer opens.

---

#### P57 Minimum return flow temperature

P57 = 0–90°C

**System 9:** The built-in mixer motor regulates the temperature to this value.

---

#### P58 Mixer dynamic Open,

#### P59 Mixer dynamic Close

P58, P59 = 5–25K

### System 9:

P58: Temperature difference between actual temperature (F5) and set temperature (P57), above which the mixer is continuously open.  
P59: Temperature difference between actual temperature (F5) and set temperature (P57), above which the mixer is continuously closed.  
▷ Lower values cause fast mixer movement and can result in vibration.

### Pump kick function (temperature test function)

**Systems 2, 9:** No function

**Systems 1, 3, 4, 5, 6, 7, 8, 10, 11, 12, 13:** The heated heat generation medium of the collector is transported to the sensor when the collector pump gets switched on for a short period so that the collector temperature can be measured.

---

### P60 Kick duration

P60 = OFF: Pump kick function is deactivated.  
P60 = 2–59 s: Collector pump runtime following pump kick.

---

### P61 Kick pause

P61 = 2–60 min: If the collector pump has not run for the duration set here, the pump is activated for the kick duration (P60).

---

### P62 Measuring time for 0.5 K increase

P62 = 1–5 min: The course of the collector temperature is controlled during this period following a pump kick. If an increase of 0.5 K is detected, the pump is started for a further minute.

---

### P63 Frost protection temperature

P63 = OFF: Function is deactivated  
P63 = -5–+5°C: If the collector temperature drops below the frost protection temperature set here, the collector pumps are switched

on. The collector pumps are switched off again when P63+2 K is reached.

### Production estimate / Volume flow counter

While the feeding pump is running, the pulses of an optional volume flow counter connected to terminal 22 are evaluated. The controller can calculate the heat production from the volume flow determined (input of the counter pulse rate in P70) and the temperature difference between collector and storage tank.

- ▷ If sensor F2 is available and installed as return flow sensor for the collector, the temperature difference between heat source and F2 is calculated. Otherwise the feed point of the charged storage tank is used for the calculation.
- ▷ **System 4:** The heat production for both collectors is determined here accordingly (temperature difference F1, F4 and F2, F4). When both collector pumps are running, the heat flows are calculated after the vol. flow distribution (P72).

The glycol type (P79) and the mixing ratio with water (P78) have to be set for the calculation.

The day's production and total production are displayed in kWh; the display of the total production is scaled automatically (kWh in MWh). The day's production is reset to zero at midnight. Both values can be reset to zero at user level by means of the key OK.

- ▷ The circulation pump must not be activated via parameter 54 = 2 while measuring the production via the connected pulse generator.
- ▷ If no pulse counter is connected, a production estimate can be carried out. To do this, enter the average volume flow through the respective collector when the feeding pump is in operation (P75 and P76). The volume flow can be established by installing a counter for a short time or by calculation (installation technician).
- ▷ The production estimate does not give the correct production value for the variable-speed pump A1 because the volume flow can only be estimated for the reduced pump speed.

- ▷ Reference value for flow rate:  
approx. 0.8 l/min per m<sup>2</sup> of collector area. **This value does not apply to low-flow installations!**

---

### P70 Pulse rate

Only in conjunction with a volume flow counter.

P70 = 0.0–100: Variable in 0.1 steps. Set the unit of the pulse rate (ml/pulse, l/pulse) with P71. Refer to the documentation on the counter for the pulse rate of a connected volume flow counter.

---

### P71 Pulse rate unit

Only in conjunction with a volume flow counter.

P71 = ml/pulse; l/pulse

---

### P72 Vol. flow distribution (system with 2 collectors)

P72 = 1:99–99:1

**System 4:** The ratio of the volume flows through the two collectors has to be entered if both feeding pumps are in operation.

---

### P75 Vol. flow - collector1 (estimated production)

Without volume flow counter only.

P75 = OFF: The real flow rate is measured if a volume flow counter is connected. Furthermore, select P75 = OFF if solar production is not to be taken into consideration (system without collector).

P75 = 0.1–100 l/min: Defined value for systems without volume flow counter for an approximate estimation of the production.

---

### P76 Vol. flow - collector2 (estimated production)

Without volume flow counter only.

P76 = OFF: The real flow rate is measured if a volume flow counter is connected. Furthermore, select P75 = OFF if solar production is not to be taken into consideration (system without collector).

P76 = 0.1 – 100 l/min: Defined value for systems without volume flow counter for an approximate estimation of the production.

---

**P78 Mixing ratio**

P78 = 0–70%

Refer to the documents supplied for information on the mixing ratio of the heat transport medium (filling of the solar system) or ask the installation technician.

---

**P79 Glycol type**

P79 = Propylene glycol; ethylene glycol

The glycol type can be found in the documents supplied, or ask the installation technician.

---

**Drain back**

---

**P84 Max tank output**

P84 = 50–75°C: Maximum temperature at the storage tank output (F4).

Pumps remain inactive if  $F4 > P84$

---

**P85 Max tank input active**

P85 = 60–110°C: Maximum temperature at the storage tank input (F3) with active pump. Pump switches off when  $F3 > P85$ .

---

**P86 Max tank output active**

P86 = 60–110°C: Maximum temperature at the storage tank output (F4) with active pump. Pump switches off when  $F4 > P86$ .

---

**P87 Filling time**

P87 = 1–10 min

---

**Software**

---

**P99 Software number and index**

(Display only)

## Technician – Parameters

---

### **Pump controller PWM/0...10V**

The relay outputs are suitable for controlling high-efficiency pumps. Variable-speed pumps with PWM or 0-10 Volt input signal can be controlled. The selection (PWM or 0-10 Volt) and settings for the pumps can be made with the following parameters.

---

#### **P101 Speed control variant**

P101 = PWM; 0...10V

Selection of pump control.

---

#### **P102 PWM base frequency**

Only when P101 = PWM is selected

P102 = 180 Hz; 2 kHz: The desired speed (0 to 100%) is converted into the corresponding PWM clock ratio.

---

#### **P103 PWM ratio ON**

Only when P101 = PWM is selected

P103 = 0–100%: PWM signal that is output for 5 seconds when the pump is activated (for safe starting).

---

#### **P104 PWM ratio OFF**

Only when P101 = PWM is selected

P104 = 0–100%: Signal for 0% speed (pump is definitely OFF), can be identical with P105. The relay is switched off.

---

#### **P105 PWM ratio Pmin**

Only when P101 = PWM is selected

P105 = 0–100%: Signal for the lowest speed when the pump is active.

---

#### **P106 PWM ratio Pmax**

Only when P101 = PWM is selected

---

P106 = 0–100%: Signal for the highest speed when the pump is active.

---

#### **P107 PWM ratio Povrspe**

Only when P101 = PWM is selected

P107 = OFF

P107 = 0–100%:

**Systems 1 to 12:** No function

**System 13:** On pumps which permit a "kick down", the signal for the highest speed is output during the filling time.

---

#### **P108 Voltage 0%**

Only when P101 = 0...10V is selected

P108 = 0.0–10 V: Setting for the minimum pump speed

---

#### **P109 Voltage 100%**

Only when P101 = 0...10V is selected

P109 = 0.0–10 V: Setting for the maximum pump speed

---

#### **P110 Voltage OFF**

Only when P101 = 0...10V is selected

P110 = 0.0–10 V: Voltage at which the pump (and corresponding relay) are switched off.

---

## Further functions

### Pump blocking protection

The controller effectively prevents the pumps blocking following longer periods out of operation. The integrated protection function activates all the pumps which have not operated within the last 24 hours each day for approx. 5 seconds at the time around 12.00.

### Pump stop (temperature check)

**Systems 2,5,6:** Filling of the secondary storage tank (sensor F3) is interrupted for 2 min every 30 minutes. After the interruption period, the start conditions for filling the primary storage tank (sensor F4) are checked.

This function is only performed when the highest priority storage tank has not reached its maximum storage tank temperature (F4 < P50-5K).

## Expert – Checklist for commissioning

- Heating controller properly wired? Particularly the bridges between L and L1' and between L1' and terminal 10, see page 30 (Connection diagram controller in socket).
- Are the sensors required for the application connected?
- Sensors that are not required are not connected.
- User parameters configured? Set at least time and day of the week, see page 12 (User – Settings).
- Expert parameters configured? See page 32 (Technician – Settings) and 36 (Technician – Parameters).
- Correct system scheme configured? See page 17 (System schemes).
- Sensors tested for plausible values? See page 9 (Automatic mode).
- Relay outputs tested? See page 34 (Relaistest (Relay test)).
- Selector switch turned to  Automatic mode?

### Accessories

#### Sensor (PT 1000)

##### Cylinder sensor SPF

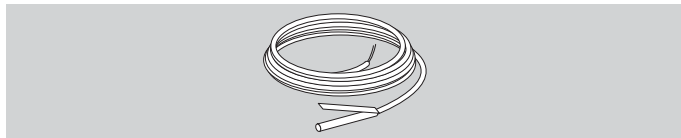

SPF1000, 3 m, Ø 6.0×50

##### Installation position

In the immersion pipe of the hot water storage tank

##### Installation

- 1** Bend contact springs around both sensors (return sensor, cylinder sensor for boiler controller) and insert them in the probe tube.
- 2** Position the return sensor at a depth of approx. 130 cm in the probe tube.
- 3** Position the cylinder sensor at a depth of approx. 70 cm in the probe tube.
- 4** For electrical connections, see page 16 (Technician - Electrical connections).

##### Sensor values

Temp.	Pt 1000 SPF1000
[°C]	[Ω]
-30	882
-25	901
-20	921
-15	941
-10	960
-5	980
0	1000
5	1019
10	1039
15	1058
20	1077
25	1097
30	1116
35	1136
40	1155
45	1174
50	1194
55	1213
60	1232
65	1251
70	1270
75	1289
80	1309
85	1328
90	1347
95	1366
100	1385
105	1404
110	1422
115	1441
120	1460
125	1479
130	1498



---

Temp. [°C]	Pt 1000 SPF1000 [Ω]
135	1517
140	1535
145	1554
150	1573
155	1591
160	1610
165	1629
170	1647
175	1666
180	1684
185	1703
190	1721
195	1740
200	1758
205	1776
210	1795
215	1813
220	1831
225	1850
230	1868
235	1886
240	1904
245	1922
250	1941

---



## Technical Specifications

### Troubleshooting

#### ? Fault

#### ! Cause

#### • Remedy

- ? In the event of a fault, the display lighting changes to red. A warning triangle  appears in the top right-hand corner.
- ▷ If the selector switch is set to Automatic mode and the display of the current statuses and temperature has been selected with the rotary knob, a  appears at the faulty sensor.
  - ▷ All pending faults can be listed using user parameter 00 (error list).

#### !

Error No.	Defective sensor (break / short-circuit)
E71	Sensor F1*
E72	Sensor F2*
E73	Sensor F3*
E79	Sensor F4*
E128	Sensor F5

\* For a detailed display (break or short-circuit) turn selector switch to temperature display F1, F2, F3 or F4, see page 10

- Check electrical connection. Possibly measure sensor value. Possibly replace sensor.
- ? The display shows error no. **E 81**.
- ! EEPROM error. An invalid parameter has been replaced by the default value.
- Check parameter values.
  - Switch mains power off and on again to reset the error no.
- ? Although pumps and mixer are indicated on the display they are not actuated.

! No bridge between terminals 2 and 3 or terminal 1 and neutral block.

- Check electrical connection.

**Should the actions described above fail to help, please contact your heating engineer.**

- ▷ Please have ready the software version (parameter P99).

### Technical Specifications

Mains voltage according to DIN IEC 60 038: ~230 V, +10/-15%

Power consumption: max. 5 W

Switching capacity of the relays: ~250 V, AC 2 (2) A

Max. current via terminal L1': 6.3 A

Protection class according to EN 60529: IP 40

Protection class according to EN 60730-1: I

Overvoltage category III (EN 60730-1)

Contamination class 2 (EN 60730-1)

Reserve power of clock: >10 h.

Permissible ambient temperature during operation: 0 to 50°C

Permissible ambient temperature during storage: -25 to 60°C

Permissible relative humidity, not condensing: 95 % r.h.

Sensor resistances F1 to F5: PT1000, 1 kΩ ±0.2% at 0°C.

## Glossary

### Flow and return flow temperature

The flow temperature is the temperature to which the heat source heats the water that transfers the heat to the consumer (e.g. radiator). The return flow temperature is the temperature of the water that flows back from the consumer to the heat source.

### Set temperature

The set temperature describes the desired temperature for hot water. The function of the differential controller is to adjust the actual temperature of the hot water to the set temperature.

### Heat source

Heat source is generally the designation for the heating boiler. It may also be a buffer storage tank however.

### Circulation pump

The circulation pump ensures that hot water is constantly available. The hot water is held in the storage tank. The circulation pump circulates it via the fresh water pipes in accordance with the heating program.

### Return temperature increase

The return temperature increase prevents the temperature difference at the heat source between flow and return becoming too great. A mixing valve is here used to add a portion of the hot flow water to the return flow to prevent condensation of the steam from the heating gas against the cold heat carrier inside the heating boiler. The minimum temperature required for this process inside the heating

boiler depends on the type of fuel (oil 47 °C, gas 55 °C). The risk of corrosion inside the heating boiler is thereby reduced significantly.

### Legionella

Legionella are bacteria that live in water. As a protective measure against legionella, the hot water storage tank is heated to 65 °C at every 20th heating-up process or at least once per week.

**Daikin Europe N.V.**  
Zandvoordestraat 300  
B-8400 Oostende, Belgium  
[www.daikineurope.com](http://www.daikineurope.com)

**ROTEX Heating Systems GmbH**  
Langwiesenstraße 10  
D-74363 Güglingen, Germany  
[www.rotex-heating.com](http://www.rotex-heating.com)

Made by  
**elster**  
Thermal Solutions

© ROTEX · 008.16 210 44\_01 · 12/2015

EN 6.6702.765-01 02.16

Printed in Germany