

**DAIKIN**



# INSTALLATION MANUAL

## Outdoor unit for air to water heat pump

ERHQ011BAV3  
ERHQ014BAV3  
ERHQ016BAV3

ERHQ011BAW1  
ERHQ014BAW1  
ERHQ016BAW1

ERLQ011BAV3  
ERLQ014BAV3  
ERLQ016BAV3

ERLQ011BAW1  
ERLQ014BAW1  
ERLQ016BAW1

	↖	↗	↘	↙	↕	A	B1	B2	C	D1	D2	E	L1/L2	
	✓						≥100							
	✓		✓	✓		≥100	≥100		≥100					
	✓				✓						≤500	≥1000		
	✓		✓	✓	✓	≥150	≥150		≥150		≤500	≥1000		
		✓									≥500			
		✓									≤500			
	✓	✓				L1<L2	≥100				≥500			
						L2<L1	≥100				≥500			
						L1<L2	L1≤H	≥250	≤500		≥750		≥1000	0<L1≤1/2H
							H<L1	L1≤H					0<L1≤1/2H	
✓	✓			✓	L2<L1	L2≤H	≥100			≥1000	≥500	≥1000	0<L2≤1/2H	
						H<L2	≥200						1/2H<L2≤H	
						H<L2	L2≤H							
	✓		✓	✓		≥200	≥300		≥1000					
	✓		✓	✓	✓	≥200	≥300		≥1000		≤500	≥1000		
		✓									≥1000			
		✓			✓			≤500		≥1000		≥1000		
						L1<L2	≥300			≥1000				
	✓	✓				L2<L1	≥250			≥1500			0<L2≤1/2H	
							≥300						1/2H<L2≤H	
						L1<L2	L1≤H	≥300	≤500		≥1000		≥1000	0<L1≤1/2H
							H<L1	L1≤H					1/2H<L1≤H	
	✓	✓			✓	L2<L1	L2≤H	≥250			≥1500	≤500	≥1000	0<L2≤1/2H
						H<L2	≥300						1/2H<L2≤H	
						H<L2	L2≤H							

1

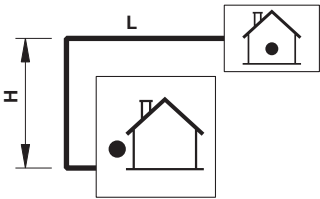

2

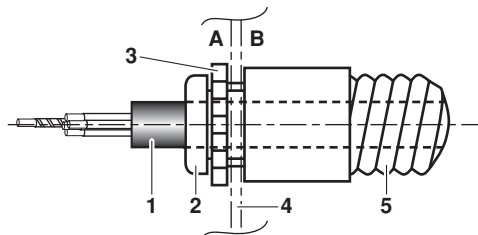

3

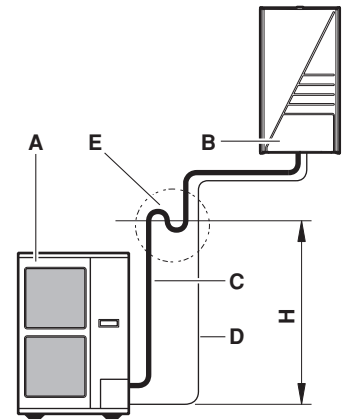

4

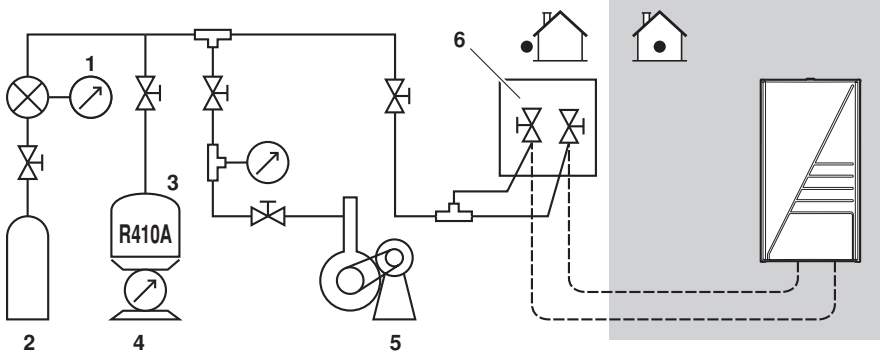

5

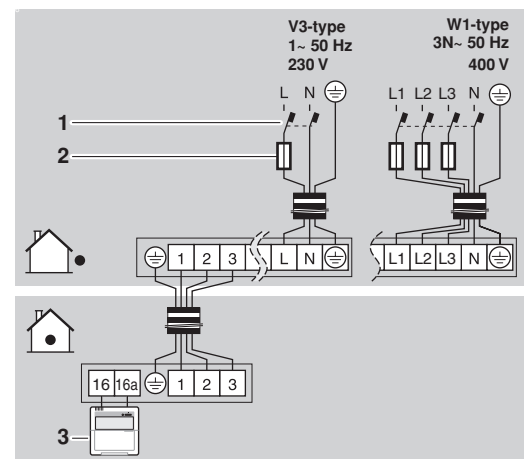

6

CE - DECLARATION-OF-COMFORMITY  
CE - KONFORMITÄTSPRÄKLÄRUNG  
CE - DECLARATION-DE-CONFORMITE  
CE - CONFORMITEITSVERKLARING

CE - DECLARACION-DE-CONFORMIDAD  
CE - DICHIARAZIONE-DI-CONFORMITA  
CE - ΔΗΛΩΣΗ ΣΥΜΜΟΡΦΩΣΗΣ

CE - DECLARACÃO-DE-CONFORMIDADE  
CE - ЗАРЯВЛЕНИЕ-О-СООТВЕТСТВИИ  
CE - ОПЕЧЕЛЕНИЕ-СЕРТИФИКАЦИИ  
CE - FÖRSÄKRAN-OM-ÖVERENSSTÄMMELSE

CE - IZJAVA-O-USKLABENOSTI  
CE - ILMHOITUS-YHDENMUUKAISLUJEDUSTA  
CE - DEKLARACJA-ZGODNOSCI  
CE - DECLARAȚIE-DE-CONFORMITATE

CE - IZJAVA-O-USKLABENOSTI  
CE - ILMHOITUS-YHDENMUUKAISLUJEDUSTA  
CE - DEKLARACJA-ZGODNOSCI  
CE - DECLARAȚIE-DE-CONFORMITATE

CE - ATTIKITES-DEKLARACIJA  
CE - ATBLISTIBAS-DEKLARACIJA  
CE - VYHLÁSENIE-ZHODY  
CE - UYUMLUJULUK-BİLDİRİSİ

## Daikin Europe N.V.

- 01 (en) déclare under its sole responsibility that the equipment to which this declaration relates:  
02 (e) erklärt auf seine alleinige Verantwortung, dass die Ausrüstung für die diese Erklärung bestimmt ist:  
03 (e) déclare sous sa seule responsabilité que l'équipement visé par la présente déclaration:  
04 (nl) verklaart hierbij op eigen exclusieve verantwoordelijkheid dat de apparatuur waarop deze verklaring betrekking heeft:  
05 (e) dichiara bajo su única responsabilidad que el equipo al que hace referencia la declaración:  
06 (e) dichiara sotto la propria responsabilità che gli apparecchi a cui è riferita questa dichiarazione:  
07 (gr) δηλώνει με αποκλειστική της ευθύνη ότι ο εξοπλισμός στον οποίο αναφέρεται η παρούσα δήλωση:  
08 (e) declara sub sua exclusiva responsabilidad que os equipamentos a que esta declaração se refere:

ERHQ011BAW1, ERHQ014BAW1, ERHQ016BAW1,  
ERHQ011BAW3, ERHQ014BAW3, ERHQ016BAW1,  
ERHQ011BAW3, ERHQ014BAW3, ERHQ016BAW3,  
ERHQ011BAW3, ERHQ014BAW3, ERHQ016BAW3,

- 01 are in conformity with the following standard(s) or other normative document(s), provided that these are used in accordance with our instructions:  
02 der/den folgenden Norm(en) oder einem anderen Normdokument oder Dokumenten entsprechend entsprechen, unter der Voraussetzung, daß sie gemäß unserer Anweisungen eingesetzt werden:  
03 são conformes às seguintes normas (s) ou outros documentos normativos (s), desde que estes sejam utilizados de acordo com as nossas instruções:  
04 conform de volgende norm(en) of één of meer andere bindende documenten zijn, op voorwaarde dat ze worden gebruikt overeenkomstig onze instructies:  
05 están en conformidad con las(s) siguiente(s) norma(s) u otro(s) documento(s) normativo(s), siempre que sean utilizados de acuerdo con nuestras instrucciones:  
06 sono conformi alle(i) seguente(i) standard(i) o altro(i) documento(i) normativo(i), a patto che vengano usati in conformità alle nostre istruzioni:  
07 είναι σύμφωνα με τις ακόλουθες προδιαγραφές ή άλλα εννοιοδοκούντα έγγραφα, υπό την προϋπόθεση ότι χρησιμοποιούνται σύμφωνα με τις οδηγίες μας:  
08 в соответствии с следующими:
- 10 under captioned or otherwise:  
11 enligt vilkoren i:  
12 gilt i henhold til bestemmelserne i:  
13 noudatteen määräyksissä:  
14 za doordien ustanoveni priedpisi:  
15 prema odredbama:  
16 követi a(z):  
17 zgodnie z postanowieniami Dyrektyw:  
18 in urma prevederilor:
- 09 conformément aux stipulations des:  
04 overeenkomstig de bepalingen van:  
06 siguiendo las disposiciones de:  
07 secondo le prescrizioni per:  
08 se попорци των διατάξεων των:  
09 de acordo com o previsto em:  
09 в соответствии с положениями:

## EN60335-2-40,

- 01 Note \* as set out in <b> and judged positively by <b>  
according to the Certificate <b>  
02 Hinweis \* wie in der <b> ausgeführt und von <b> positiv beurteilt gemäß Zertifikat <b>  
03 Remarque \* le quel défini dans <b> et évalué positivement par <b> conformément au Certificat <b>  
04 Bemerk \* zoals vermeld in <b> en positief beoordeeld door <b> overeenkomstig Certificat <b>  
05 Nota \* como se establece en <b> y es valorado positivamente por <b> de acuerdo con el Certificado <b>
- 06 Nota \* delineato nei <b> e giudicato positivamente da <b> secondo il Certificato <b>  
07 Zbirka \* otkuc, uopisano što <b> kao kvaliteta članka onto to <b> odobrava je to fluoromimiko <b>  
08 Nota \* tal como estabelecido em <b> e com o parecer positivo de <b> de acordo com o Certificado <b>  
09 Примечание \* как указано в <b> и в соответствии с Конкретностью Certificat <b>  
10 Bemerk \* som antgår i <b> og positivt vurderet af <b> i henhold til Certificat <b>

09 (en) заверяет, исключительно под свою ответственность, что оборудование, к которому относится настоящее заявление:  
10 (e) erklærer sig ensansvarlig, at udstyret, som er omfattet af denne erklæring:  
11 (e) déclare à l'égards de l'équipement qui est visé par la présente déclaration:  
12 (n) erklærer et fuldstændigt ansvar for at det udstyr som berøres af denne erklæring, innehæver at:  
13 (nl) imachtigает voornamelijk aansprakelijkheid, dat de apparatuur waartoe deze verklaring betrekking heeft:  
14 (e) prohlašuje ve své plné odpovědnosti, že zařízení, k němuž se toto prohlášení vztahuje:  
15 (gr) δηλώνει υπό αποκλειστική του ευθύνη ότι ο εξοπλισμός στον οποίο αναφέρεται η παρούσα δήλωση:  
16 (e) declara bajo su exclusiva responsabilidad que el equipo a que se refiere esta declaración:

17 (e) déclare que la présente déclaration concerne exclusivement le matériel qui est visé par la présente déclaration:  
18 (e) déclare que la présente déclaration concerne exclusivement le matériel qui est visé par la présente déclaration:  
19 (e) z svo odgovornosti izjavlja, da je oprema navedena, na katero se izjava nanaša:  
20 (nl) knimlaba omia labeiklu vastuutaset, et käslova deklaratsiooni alla kuluva varustuse:  
21 (e) deklaaruje na svoj odgovornost, ve obopredavajeto, za vesoto ve otvazno tazaj dekloracijo:  
22 (t) visko savo atsakomybę skelbia, kad įrengia, kuriai laikoma ši deklaracija:  
23 (v) ar plinu atbildību apliecinu, ka tālāk aprakstītais iekārtas, uz kurām attiecas šī deklarācija:  
24 (e) vyhlásuje na vlastní zodpovednosť, že zariadenie, na ktoré sa vzťahuje toto vyhlásenie:  
25 (tr) lamamen kendiri sorumluluğunda olmaks üzere bir bildirimli ilgili olduğu donanimimin aşağıdaki gibi olduğunu beyan eder:

16 megfelelnek az alábbi szabvány(ok)nak vagy egyéb irányadó dokumentum(ok)nak, ha azokat előírás szerint használják:  
17 megfelel a következő szabvány(ok)nak, ha azokat előírás szerint használják:  
18 sunt în conformitate cu următorul (următoarele) standard(e) sau alte(i) documente (documente) normative), cu condiția ca acestea să fie utilizate în conformitate cu instrucțiunile noastre  
19 conform des normes ou autres documents normatifs (normatifs), pour autant qu'ils soient utilisés conformément à nos instructions:  
20 conform de volgende norm(en) of één of meer andere bindende documenten zijn, op voorwaarde dat ze worden gebruikt overeenkomstig onze instructies:  
21 соответствуют на следующие стандарты или другие нормативные документы, при условии, что они используются в соответствии с нашими инструкциями:  
22 atitinka žemiau nurodytus standartus ir (arba) kitus norminius dokumentus su sąlyga, kad yra naudojami pagal mūsų nurodymus:  
23 tad, ja labeiti atbilstošā roztaģa norādījumiem, atbilst sekojošiem standartiem un citiem normatīviem dokumentiem:  
24 sú v zhode s nasledovnými (normou) alebo inými (normatívnymi) dokumentami, za predpokladu, že sa používajú v súlade s našimi návodmi:  
25 inünin, lalmatlarına göre kulanılması koşullarına aşağıdaki standartlar ve norm belirlen belgelerle uyumludur:

08 estão em conformidade com a(s) seguinte(s) norma(s) ou outro(s) documento(s) normativo(s), desde que estes sejam utilizados de acordo com as nossas instruções:  
09 соответствуют следующим стандартам или другим нормативным документам, при условии их использования согласно нашим инструкциям:  
10 overholder følgende standard(er) eller andre andre retningsgivende dokument(er), brudsat at disse anvendes i henhold til vores instruks:  
11 respektive utrustning är utförd i överensstämmelse med och följer följande standard(er) eller andra normgivande dokument, under förutsättning att användning sker i överensstämmelse med våra instruktioner:  
12 respektive udstyr er i overensstemmelse med følgende standard(er) eller andre normgivende dokument(er), under forudsætning at disse brudes i henhold til våre instruks:  
13 nastavaq searaaven standarden ja muuden ohjeellisten dokumenttien vaatimuksia edellyttäen, että niitä käytetään ohjeidemme mukaisesti:  
14 za předpokladu, že jsou využívány v souladu s našimi pokyny, odpovídají následujícím normám nebo normativním dokumentům:  
15 i skladu sa stajędz standardom(i)mi) ii drugim normatívním dokumentom(i)mi), uz uvjet da se oni koriste u skladu s našim uputama:

01 Directives, as amended.  
02 Direktiven, med förändringar.  
03 Directives, telles que modifiées.  
04 Richtlijnen, zoals gewijzigd.  
05 Directivas, según lo emendado.  
06 Direktives, según lo emendado.  
07 Обнови, оне, џову, пономонџи.  
08 Directivas, conforme alteração em.  
09 Директиве, со всеми поправками.

## Low Voltage 2006/95/EC Machinery 98/37/EC (→ 29.12.2009) Electromagnetic Compatibility 2004/108/EC \*

16 Megjegyzés \* a(z) <b> alapján, a(z) <b> igazolta a megfelelést, a(z) <b> tanúsítvány szerint.  
17 Uwaga \* zgodnie z dokumentacją <b>, pozytywną opinią jako cum esse stabilis in <b> si anerat pozitiv hysklysiy/Sertifikaat <b> mukassati.  
18 Nota \* tal como estabelecido em <b> e com o parecer positivo de <b> de acordo com o Certificado <b>  
19 Opomba \* kar je doobreno v <b> a pozitivno zjeleno <b> v skladu s ovsledenim <b>  
20 Märkus \* nagu on näidatud dokumentis <b> ja heaks kiidetud <b> järgi vastavalt sertifikaadile <b>

10 Direktiver, med senere ændringer.  
11 Direktiv, med förändringar.  
12 Directives, telles que modifiées.  
13 Richtlijnen, zoals gewijzigd.  
14 plament zneni.  
15 Smernice, kako je izmjenjeno.  
16 irányelvek és módosítások rendelkezéseit.  
17 pöznejszy popravkami.  
18 Directivelor, cu amendamentele respective.

21 Забелешка \* картото е коректно в <b> и оценено позитивно от <b> согласно Сертификата <b>  
22 Pastaba \* kaip nustatyta <b> ir kaip teigiamai nuspresta <b> pagal Sertifikaat <b>  
23 Poznámka \* ka nřadil s <b> in atbilstoš <b> pozitívam vērtējumam saskaņā ar sertifikātu <b>  
24 Poznámka \* ako bolo uvedené v <b> a pozitívne zistené <b> v súlade s osvedčením <b>  
<b> <b> bejrtitdigi gibi ve <b> Sertifikasına göre <b> tarafından olumlu olarak değerlendirildiği gibi.

<A>	DAIKIN.TCF.021F13.09-2009
<B>	KEMA (NB0344)
<C>	2024351-OUA/EMC02-4565



**CONTENTS**

	Page
Safety considerations .....	1
Before installation .....	2
Selecting installation site .....	3
Precautions on installation .....	4
Installation servicing space .....	5
Refrigerant pipe size and allowable pipe length .....	5
Precautions on refrigerant piping .....	6
Refrigerant piping .....	8
Leak test and vacuum drying .....	9
Charging refrigerant .....	10
Pump down operation .....	11
Electrical wiring work .....	12
Test operation .....	14
Maintenance and servicing .....	15
Disposal requirements .....	15
Unit specifications .....	15
Wiring diagram .....	16



READ THESE INSTRUCTIONS CAREFULLY BEFORE INSTALLATION. KEEP THIS MANUAL IN A HANDY PLACE FOR FUTURE REFERENCE.

IMPROPER INSTALLATION OR ATTACHMENT OF EQUIPMENT OR ACCESSORIES COULD RESULT IN ELECTRIC SHOCK, SHORT-CIRCUIT, LEAKS, FIRE OR OTHER DAMAGE TO THE EQUIPMENT. BE SURE ONLY TO USE ACCESSORIES MADE BY DAIKIN WHICH ARE SPECIFICALLY DESIGNED FOR USE WITH THE EQUIPMENT AND HAVE THEM INSTALLED BY A PROFESSIONAL.

ALL ACTIVITIES DESCRIBED IN THIS MANUAL SHALL BE CARRIED OUT BY A LICENSED TECHNICIAN.

BE SURE TO WEAR ADEQUATE PERSONEL PROTECTION EQUIPMENT (PROTECTION GLOVES, SAFETY GLASSES, ...) WHEN PERFORMING INSTALLATION, MAINTENANCE OR SERVICE TO THE UNIT.

IF UNSURE OF INSTALLATION PROCEDURES OR USE, ALWAYS CONTACT YOUR DAIKIN DEALER FOR ADVICE AND INFORMATION.

The English text is the original instruction. Other languages are translations of the original instructions.

**SAFETY CONSIDERATIONS**

The precautions listed here are divided into the following four types. They all cover very important topics, so be sure to follow them carefully.

Meanings of **DANGER**, **WARNING**, **CAUTION** and **NOTE** symbols.



**DANGER**

Indicates an imminently hazardous situation which, if not avoided, will result in death or serious injury.

**WARNING**

Indicates a potentially hazardous situation which, if not avoided, could result in death or serious injury.

**CAUTION**

Indicates a potentially hazardous situation which, if not avoided, may result in minor or moderate injury. It may also be used to alert against unsafe practices.

**NOTE**

Indicates situations that may result in equipment or property-damage accidents only.

**Danger**

- Before touching electric terminal parts, turn off power switch.
- When service panels are removed, live parts can be easily touched by accident.  
Never leave the unit unattended during installation or servicing when the service panel is removed.
- Do not touch water pipes during and immediately after operation as the pipes may be hot. Your hand may suffer burns. To avoid injury, give the piping time to return to normal temperature or be sure to wear proper gloves.

**Warning**

- Ask your dealer or qualified personnel to carry out installation work. Do not install the machine by yourself.  
Improper installation may result in water leakage, electric shocks or fire.
- Perform installation work in accordance with this installation manual.  
Improper installation may lead to water leakage, electric shocks or fire.
- Consult your local dealer regarding what to do in case of refrigerant leakage. When the unit is to be installed in a small room, it is necessary to take proper measures so that the amount of any leaked refrigerant does not exceed the concentration limit in the event of a leakage. Otherwise, this may lead to an accident due to oxygen depletion.
- Be sure to use only the specified accessories and parts for installation work.  
Failure to use the specified parts may result in water leakage, electric shocks, fire, or the unit falling.
- Install the unit on a foundation that can withstand its weight.  
Insufficient strength may result in the fall of equipment and causing injury.
- Carry out the specified installation work in consideration of strong winds, typhoons, or earthquakes.  
Improper installation work may result in accidents due to fall of equipment.

- Make certain that all electrical work is carried out by qualified personnel according to the local laws and regulations and this installation manual, using a separate circuit. Insufficient capacity of the power supply circuit or improper electrical construction may lead to electric shocks or fire.
- Make sure that all wiring is secure, using the specified wires and ensuring that external forces do not act on the terminal connections or wires. Incomplete connection or fixing may cause a fire.
- When wiring between the indoor and outdoor units, and wiring the power supply, form the wires so that the frontside panel can be securely fastened. If the frontside panel is not in place, overheat of the terminals, electric shocks or a fire may be caused.
- If refrigerant gas leaks during installation work, ventilate the area immediately. Toxic gas may be produced if refrigerant gas comes into contact with fire.
- Do not touch the refrigerant pipes during and immediately after operation as the refrigerant pipes may be hot or cold, depending on the condition of the refrigerant flowing through the refrigerant piping, compressor, and other refrigerant cycle parts. Your hands may suffer burns or frostbite if you touch the refrigerant pipes. To avoid injury, give the pipes time to return to normal temperature or, if you must touch them, be sure to wear proper gloves.
- After completing the installation work, check to make sure that there is no leakage of refrigerant gas. Toxic gas may be produced if refrigerant gas leaks into the room and comes into contact with a source of fire, such as a fan heater, stove or cooker.
- When planning to relocate former installed units, you must first recover the refrigerant after the pump down operation. Refer to chapter "Pump down operation" on page 11.
- Never directly touch any accidental leaking refrigerant. This could result in severe wounds caused by frostbite.
- Be sure to install an earth leakage circuit breaker in accordance with relevant local and national regulations. Failure to do so may cause electrical shock and fire.

### Caution

- Earth the unit. Earthing resistance should be according to national regulations. Do not connect the earth wire to gas or water pipes, lightning conductor or telephone earth wire. Incomplete earthing may cause electric shocks. 
- Gas pipe. Ignition or explosion may occur if the gas leaks.
- Water pipe. Hard vinyl tubes are not effective earths.
- Lightning conductor or telephone earth wire. Electric potential may rise abnormally if struck by a lightning bolt.
- Install drain piping according to this installation manual to ensure good drainage, and insulate the pipe to prevent condensation. See combination table in "Possible options" on page 3. Improper drain piping may cause water leakage, and make the furnitures get wet.
- Install the indoor and outdoor units, power wire and connecting wire at least 1 meter away from televisions or radios to prevent image interference or noise. (Depending on the radio waves, a distance of 1 meter may not be sufficient to eliminate the noise.)
- Do not rinse the outdoor unit. This may cause electric shocks or fire.
- Do not install the unit in places such as the following:
  - Where there is mist of mineral oil, oil spray or vapour for example a kitchen. Plastic parts may deteriorate, and cause them to fall out or water to leak.

- Where corrosive gas, such as sulphurous acid gas, is produced. Corrosion of copper pipes or soldered parts may cause the refrigerant to leak.
- Where there is machinery which emits electromagnetic waves. Electromagnetic waves may disturb the control system, and cause malfunction of the equipment.
- Where flammable gases may leak, where carbon fiber or ignitable dust is suspended in the air or where volatile flammables, such as thinner or gasoline, are handled. Such gases may cause a fire.
- Where the air contains high levels of salt such as that near the ocean.
- Where voltage fluctuates a lot, such as that in factories.
- In vehicles or vessels.
- Where acidic or alkaline vapour is present.
- Do not allow a child to mount on the outdoor unit or avoid placing any object on the unit. Falling or tumbling may result in injury.
- For use of units in applications with temperature alarm settings it is advised to foresee a delay of 10 minutes for signalling the alarm in case the alarm temperature is exceeded. The unit may stop for several minutes during normal operation for "defrosting the unit", or when in "thermosta-stop" operation.

## BEFORE INSTALLATION



Since maximum working pressure is 4.0 MPa or 40 bar, pipes of larger wall thickness may be required. Refer to paragraph "Selection of piping material" on page 6.

### Precautions for R410A

- The refrigerant requires strict cautions for keeping the system clean, dry and tight.
  - Clean and dry Foreign materials (including mineral oils or moisture) should be prevented from getting mixed into the system.
  - Tight Read "Precautions on refrigerant piping" on page 6 carefully and follow these procedures correctly.
- Since R410A is a mixed refrigerant, the required additional refrigerant must be charged in its liquid state. (If the refrigerant is in state of gas, its composition changes and the system will not work properly).
- The connected indoor unit must be the EKHBH/X016 unit designed exclusively for R410A.

### Installation

- For installation of the indoor unit, refer to the indoor unit installation manual.
- Never operate the unit without the thermistor (R3T, R4T) or pressure sensors (S1NPH, S1PH), burning of the compressor may result.
- Be sure to confirm the model name and the serial no. of the outer (front) plates when attaching/detaching the plates to avoid mistakes.
- When closing the service panels, take care that the tightening torque does not exceed 4.1 N·m.

## Model

ERLQ units include special equipment (insulation, bottom plate heater,...) to ensure good operation in areas where low ambient temperature can occur together with high humidity conditions. In such conditions the ERHQ models may experience problems with severe ice build up on the aircooled coil. In case such conditions are expected, the ERLQ must be installed instead. These models contain countermeasures (insulation, bottom plate heater,...) to prevent freeze up.

### NOTE



- An ERLQ0\***BA** outdoor unit can only be connected to an EKHBH/X016**BA** indoor unit (bottom plate heater at outdoor unit has to be controlled by indoor unit).
- An ERHQ0\***BA** outdoor unit can be connected to an EKHBH/X016**BA** indoor unit or to an EKHBH/X016**AA/AB** indoor unit (if a bottom plate heater kit is required, see "Possible options" on page 3).

## Accessories

- Check if the following accessories are included with the unit

Installation manual	1	
Cable tie	2	
Fluorinated greenhouse gases label	1	
Multilingual fluorinated greenhouse gases label	1	

See the figure below for the location of the accessories.

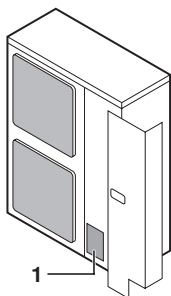

1 Accessories

- Possible options

	Bottom plate heater	Drain socket
ERLQ	Standard	Use prohibited
ERHQ	Optional kit <sup>(a)</sup>	Optional kit <sup>(a)</sup>

(a) Combination of both options is prohibited.

	EKBPHT16Y*	EKBPTH16A
EKHBH/X016 <b>AA/AB</b>	Possible	Not allowed
EKHBH/X016 <b>BA</b>	Possible	Possible

## Handling

As shown in the figure below, slowly move the unit by grabbing the left and right grips. Position your hands on the corner instead of grabbing the air inlet to avoid deforming the casing.

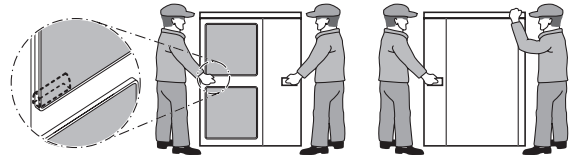

To avoid injury, do not touch the air inlet or aluminium fins of the unit.

## SELECTING INSTALLATION SITE



### CAUTION

- Make sure to provide for adequate measures in order to prevent that the outdoor unit be used as a shelter by small animals.
- Small animals making contact with electrical parts can cause malfunctions, smoke or fire. Please instruct the customer to keep the area around the unit clean.

- Select an installation site where the following conditions are satisfied and that meets with your customer's approval.
  - Places which are well-ventilated.
  - Places where the unit does not bother next-door neighbours.
  - Safe places which can withstand the unit's weight and vibration and where the unit can be installed level.
  - Places where there is no possibility of flammable gas or product leak.
  - The equipment is not intended for use in a potentially explosive atmosphere.
  - Places where servicing space can be well ensured.
  - Places where the indoor and outdoor units' piping and wiring lengths come within the allowable ranges.
  - Places where water leaking from the unit cannot cause damage to the location (e.g. in case of a blocked drain pipe).
  - Places where the rain can be avoided as much as possible.
  - Do not install the unit in places often used as work place. In case of construction works (e.g. grinding works) where a lot of dust is created, the unit must be covered.
  - Do not place any objects or equipment on top of the unit (top plate).
  - Do not climb, sit or stand on top of the unit,
  - Be sure that sufficient precautions are taken, in accordance with relevant local and national regulations, in case of refrigerant leakage.
- When installing the unit in a place exposed to strong wind, pay special attention to the following.
 

Strong winds of 5 m/sec or more blowing against the outdoor unit's air outlet causes short circuit (suction of discharge air), and this may have the following consequences:

  - Deterioration of the operational capacity.
  - Frequent frost acceleration in heating operation.
  - Disruption of operation due to rise of high pressure.
  - When a strong wind blows continuously on the face of the unit, the fan can start rotating very fast until it breaks.

Refer to the figures for installation of this unit in a place where the wind direction can be foreseen.

- Turn the air outlet side toward the building's wall, fence or screen.

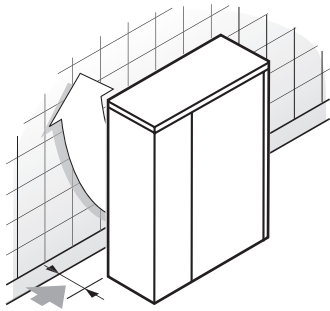

► Make sure there is enough room to do the installation

- Set the outlet side at a right angle to the direction of the wind.

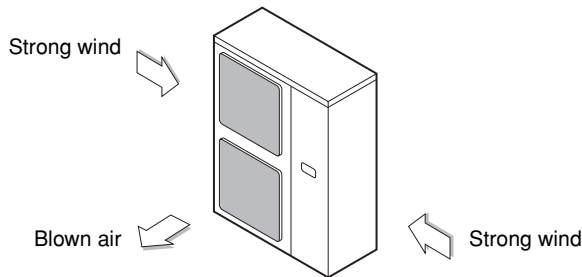

- 3 Prepare a water drainage channel around the foundation, to drain waste water from around the unit.
- 4 If the water drainage of the unit is not easy, please build up the unit on a foundation of concrete blocks, etc. (the height of the foundation should be maximum 150 mm).
- 5 If you install the unit on a frame, please install a waterproof plate within 150 mm of the underside of the unit in order to prevent the invasion of water from the lower direction.
- 6 When installing the unit in a place frequently exposed to snow, pay special attention to elevate the foundation as high as possible.
- 7 If you install the unit on a building frame, please install a waterproof plate (field supply)(within 150 mm of the underside of the unit) or use a drain kit (refer to combination table in "Possible options" on page 3) in order to avoid the drainwater dripping. (See figure).



### Selecting a location in cold climates

Refer to "Model" on page 3.

**NOTE** When operating the outdoor unit in a low outdoor ambient temperature, be sure to follow the instructions described below.

- To prevent exposure to wind, install the outdoor unit with its suction side facing the wall.
- Never install the outdoor unit at a site where the suction side may be exposed directly to wind.
- To prevent exposure to wind, install a baffle plate on the air discharge side of the outdoor unit.

- In heavy snowfall areas it is very important to select an installation site where the snow will not affect the unit. If lateral snowfall is possible, make sure that the heat exchanger coil is not affected by the snow (if necessary construct a lateral canopy).

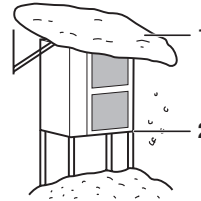

- 1 Construct a large canopy.
- 2 Construct a pedestal. Install the unit high enough off the ground to prevent burying in snow.

### PRECAUTIONS ON INSTALLATION

- Check the strength and level of the installation ground so that the unit will not cause any operating vibration or noise after installation.
- In accordance with the foundation drawing in the figure, fix the unit securely by means of the foundation bolts. (Prepare four sets of M12 foundation bolts, nuts and washers each which are available on the market.)
- It is best to screw in the foundation bolts until their length are 20 mm from the foundation surface.

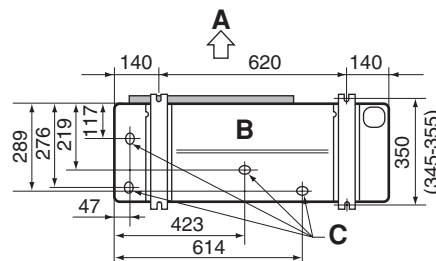

- A Discharge side
- B Bottom view (mm)
- C Drain hole

### Drain work

Check in the combination table under "Possible options" on page 3 whether drain work is allowed. In case drain work on your unit is allowed and the installation site requires drain work, then follow the guidelines below.

- Drain kits for drainage are available as option.
- If drain work from the outdoor unit causes trouble (for example, if the drain water may splash on people) provide the drain piping using a drain socket (optional).
- Make sure the drain works properly.

**NOTE** If drain holes of the outdoor unit are covered by a mounting base or by floor surface, raise the unit in order to provide a free space of more than 100 mm under the outdoor unit.

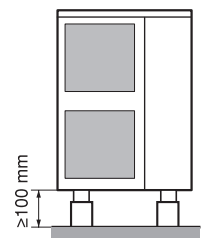

## Installation method for prevention of falling over

If it is necessary to prevent the unit from falling over, install as shown in the figure.

- prepare all 4 wires as indicated in the drawing
- unscrew the top plate at the 4 locations indicated A and B
- put the screws through the nooses and screw them back tight

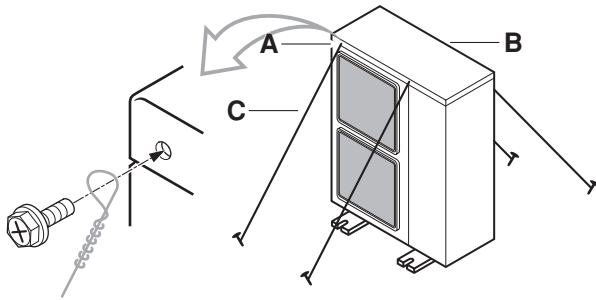

- A Location of the 2 fixation holes on the front side of the unit
- B Location of the 2 fixation holes on the rear side of the unit
- C Wires: field supply

## INSTALLATION SERVICING SPACE

The numerical figures used in the figures represent the dimensions in mm.

(Refer to "Precautions on installation" on page 4)

### Precaution

(A) In case of non-stacked installation (See figure 1)

- |  |                         |   |  |
|--|-------------------------|---|--|
|  | Suction side obstacle   | ✓ | Obstacle is present  |
|  | Discharge side obstacle | 1 | In these cases, close the bottom of the installation frame to prevent the discharged air from being bypassed |
|  | Left side obstacle      |   |  |
|  | Right side obstacle     | 2 | In these cases, only 2 units can be installed.   |
|  | Top side obstacle       |   | This situation is not allowed  |

(B) In case of stacked installation

1. In case obstacles exist in front of the outlet side.

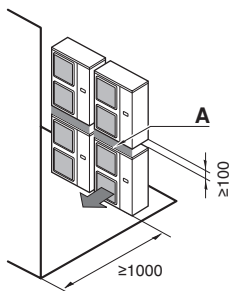

2. In case obstacles exist in front of the air inlet.

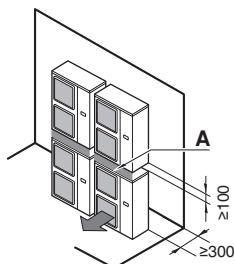

Do not stack more than one unit.

About 100 mm is required as the dimension for laying the upper outdoor unit's drain pipe. Get the portion A sealed so that air from the outlet does not bypass.

(C) In case of multiple-row installation (for roof top use, etc.)

1. In case of installing one unit per row.

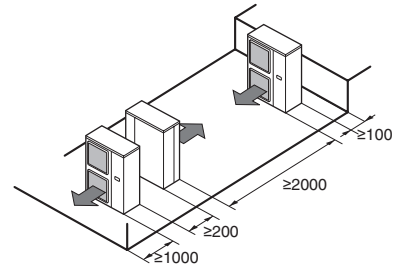

2. In case of installing multiple units (2 units or more) in lateral connection per row.

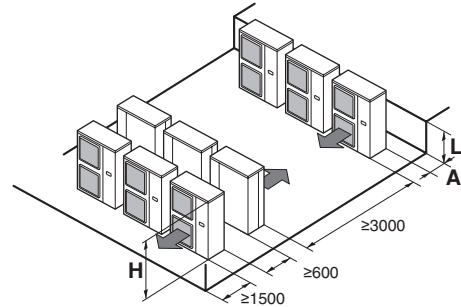

Relation of dimensions of H, A and L are shown in the table below.

	L	A
L ≤ H	0 < L ≤ 1/2H	250
	1/2H < L	300
H < L	Installation not allowed	

## REFRIGERANT PIPE SIZE AND ALLOWABLE PIPE LENGTH



- Piping and other pressure containing parts shall comply with the applicable national and international regulations and shall be suitable for refrigerant. Use phosphoric acid deoxidised seamless copper for refrigerant.
- Installation shall be done by a licensed refrigerant technician, the choice of materials and installation shall comply with national and international regulations. In Europe the EN378 is the application standard that shall be used.



### To persons in charge of piping work:

- Be sure to open the stop valve after piping installing and vacuuming is complete. (Running the system with the valve closed may break the compressor.)
- It is forbidden to discharge refrigerant into the atmosphere. Collect the refrigerant in accordance with the freon collection and destruction law.



## Selection of piping material

- Construction material: phosphoric acid deoxidised seamless copper for refrigerant.
- Temper grade: use piping with temper grade in function of the pipe diameter as listed in table below.
- The pipe thickness of the refrigerant piping should comply with relevant local and national regulations. The minimal pipe thickness for R410A piping must be in accordance with the table below.

Pipe Ø	Temper grade of piping material	Minimal thickness t (mm)
9.5	O	0.80
15.9	O	1.00

O=Annealed

## Refrigerant pipe size

The pipes between outdoor unit and indoor unit should have the same size as the outdoor connections.

Refrigerant pipe size (mm)	
Gas pipe	Ø15.9
Liquid pipe	Ø9.5

## Allowable pipe length and height difference

See the table below concerning lengths and heights. Refer to figure 2. Assume that the longest line in the figure corresponds with the actual longest pipe, and the highest unit in the figure corresponds with the actual highest unit.

Allowable pipe length	V3		W1	
	Maximum total one-way piping length <sup>(a)</sup>	75 m (95 m)		
Maximum height between indoor and outdoor	30 m			
Chargeless length				
L	≤30 m		≤10 m	

(a) Parenthesized figure represents the equivalent length.

## PRECAUTIONS ON REFRIGERANT PIPING

- Do not allow anything other than the designated refrigerant to get mixed into the freezing cycle, such as air, etc. If any refrigerant gas leaks while working on the unit, ventilate the room thoroughly right away.

- Use R410A only when adding refrigerant

### Installation tools:

Make sure to use installation tools (gauge manifold charge hose, etc.) that are exclusively used for R410A installations to withstand the pressure and to prevent foreign materials (e.g. mineral oils and moisture) from mixing into the system.

### Vacuum pump:

Use a 2-stage vacuum pump with a non-return valve  
Make sure the pump oil does not flow oppositely into the system while the pump is not working.

Use a vacuum pump which can evacuate to -100.7 kPa (5 Torr, -755 mm Hg).

- In order to prevent dirt, liquid or dust from entering the piping, cure the piping with a pinch or taping.

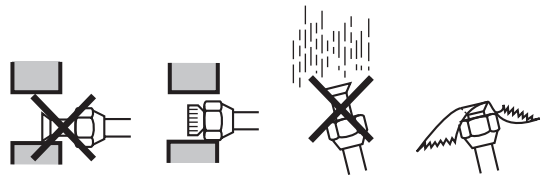

Place	Installation period	Protection method
Outdoor unit	More than a month	Pinch the pipe
	Less than a month	
Indoor unit	Regardless of the period	Pinch or tape the pipe

Great caution is needed when passing copper tubes through walls.

- Piping should be mounted so that the flare is not subjected to mechanical stress.

## Flaring guidelines

- Flares should not be re-used. New ones should be made in order to prevent leaks.
- Use a pipe cutter and flare tool suitable for the refrigerant used.
- Only use the flare nuts included with the unit. Using different flare nuts may cause the refrigerant to leak.
- Please refer to the table for flaring dimensions and tightening torques (too much tightening will result in splitting the flare).

Piping size (mm)	Tightening torque (N·m)	Flare dimensions A (mm)	Flare shape (mm)
Ø9.5	33~39	12.8~13.2	
Ø15.9	63~75	19.4~19.7	

- When connecting the flare nut, coat the flare inner surface with ether oil or with ester oil and initially tighten 3 or 4 turns by hand before tightening firmly.

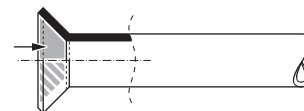

- When loosening a flare nut, always use two wrenches together. When connecting the piping, always use a spanner and torque wrench together to tighten the flare nut to prevent flare nut cracking and leaks.

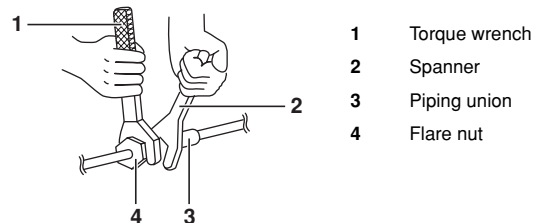

### Not recommended, but in case of emergency

Should you be forced to connect the piping without a torque wrench, follow the following installation method:

- Tighten the flare nut using a spanner until the tightening torque suddenly increases.
- From that position further tighten the flare nut the angle listed below:

Piping size (mm)	Further tightening angle (degrees)	Recommended arm length of spanner (mm)
Ø9.5	60~90	±200
Ø15.9	30~60	±300

## Brazing guidelines

- Make sure to blow through with nitrogen when brazing. Blowing through with nitrogen prevents the creation of large quantities of oxidized film on the inside of the piping. An oxidized film adversely affects valves and compressors in the refrigerating system and prevents proper operation.
- The nitrogen pressure should be set to 0.02 MPa (i.e., just enough so it can be felt on the skin) with a pressure-reducing valve.

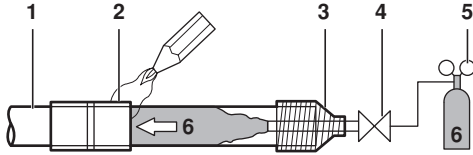

- Refrigerant piping
- Part to be brazed
- Taping
- Manual valve
- Pressure-reducing valve
- Nitrogen

- Do not use anti-oxidants when brazing the pipe joints. Residue can clog pipes and break equipment.
- Do not use flux when brazing copper-to-copper refrigerant piping. Use phosphor copper brazing filler alloy (BCuP) which does not require flux.
- Flux has an extremely harmful influence on refrigerant piping systems. For instance, if chlorine based flux is used, it will cause pipe corrosion or, in particular, if the flux contains fluorine, it will deteriorate the refrigerant oil.

## Stop valve operation

### Cautions on handling the stop valve

- Make sure to keep both stop valves open during operation.
- The figure below shows the name of each part required in handling the stop valve.

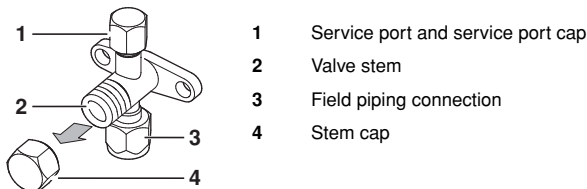

- The stop valve is factory closed.
- Do not apply excessive force to the valve stem. Doing so may break the valve body.
- Since the stop valve mounting plate may be deformed if only a torque wrench is used to loosen or tighten the flare nut, always make sure to secure the stop valve with a spanner, then loosen or tighten the flare nut with a torque wrench. Do not place the spanner on the stem cap, as this could cause a refrigerant leak.

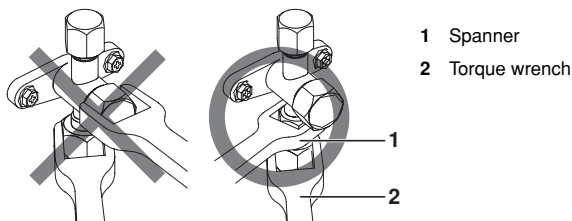

- When it is expected that the operating pressure will be low (for example, when cooling will be performed while the outside air temperature is low), sufficiently seal the flare nut in the stop valve on the gas line with silicon sealant to prevent freezing.



### Opening/closing the stop valve

#### Opening the stop valve

- Remove the valve cover.
- Insert a hexagon wrench (liquid side: 4 mm/gas side: 6 mm) into the valve stem and turn the valve stem counterclockwise.
- When the valve stem cannot be turned any further, stop turning. The valve is now open.

#### Closing the stop valve

- Remove the valve cover.
- Insert a hexagon wrench (liquid side: 4 mm/gas side: 6 mm) into the valve stem and turn the valve stem clockwise.
- When the valve stem cannot be turned any further, stop turning. The valve is now closed.

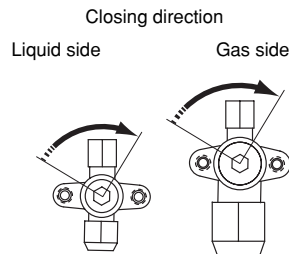

### Cautions on handling the stem cap

- The stem cap is sealed where indicated by the arrow. Take care not to damage it.
- After handling the stop valve, make sure to tighten the stem cap securely. For the tightening torque, refer to the table below.
- Check for refrigerant leaks after tightening the stem cap.

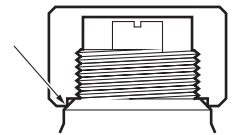

### Cautions on handling the service port

- Always use a charge hose equipped with a valve depressor pin, since the service port is a Schrader type valve.
- After handling the service port, make sure to tighten the service port cap securely. For the tightening torque, refer to the table below.
- Check for refrigerant leaks after tightening the service port cap.

## Tightening torques

Item	Tightening torque (N·m)
Stem cap, liquid side	13.5~16.5
Stem cap, gas side	22.5~27.5
Service port cap	11.5~13.9

## REFRIGERANT PIPING

- Field pipes can be installed in four directions.

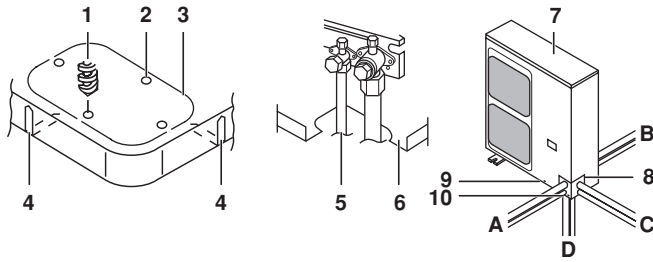
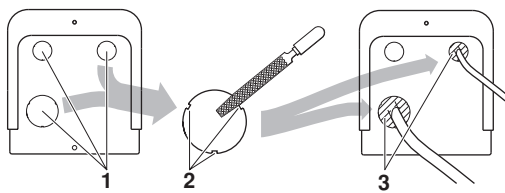

Figure - Field pipes in four directions

- |    |                                  |
|----|----------------------------------|
| 1  | Drill                            |
| 2  | Centre area around knockout hole |
| 3  | Knockout hole                    |
| 4  | Slit                             |
| 5  | Connecting pipe                  |
| 6  | Bottom frame                     |
| 7  | Front plate                      |
| 8  | Pipe outlet plate                |
| 9  | Screw front plate                |
| 10 | Pipe outlet plate screw          |
| A  | Forward                          |
| B  | Backward                         |
| C  | Sideways                         |
| D  | Downward                         |
- Cutting out the two slits makes it possible to install as shown in the figure "Field pipes in four directions". (Use a metal saw to cut out the slits.)
  - To install the connecting pipe to the unit in a downward direction, make a knockout hole by penetrating the centre area around the knockout hole using a  $\varnothing 6$  mm drill. (See figure "Field pipes in four directions".)
  - After knocking out the knock-out, it is recommended to apply repair paint to the edge and the surrounding end surfaces to prevent rusting.
  - When passing electrical wiring through the knock holes, remove any burrs from the knock holes and wrap the wiring with protective tape to prevent damage.
  - If there is any possibility that small animals enter the system through the knock holes, plug the holes with packing materials (to be prepared on-site).



- |   |                   |
|---|-------------------|
| 1 | Knockout hole     |
| 2 | Burr              |
| 3 | Packing materials |

## Preventing foreign objects from entering

Plug the pipe through-holes with putty or insulating material (procured locally) to stop up all gaps, as shown in the figure.

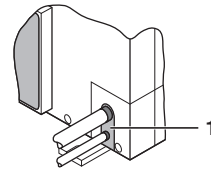

- |   |   |
|---|---|
| 1 | Putty or insulating material (produced locally) |
|---|---|

Insects or small animals entering the outdoor unit may cause a short circuit in the electrical box.

## Precautions when connecting field piping and regarding insulation

- Be careful not to let the indoor and outdoor piping come into contact with the compressor terminal cover. If the liquid-side piping insulation might come into contact with it, adjust the height as shown in the figure below. Also, make sure the field piping does not touch the bolts or outer panels of the compressor.
- When the outdoor unit is installed above the indoor unit the following can occur:  
The condensated water on the stop valve can move to the indoor unit. To avoid this, please cover the stop valve with sealing material.
- If the temperature is higher than  $30^{\circ}\text{C}$  and the humidity is higher than RH 80%, then the thickness of the sealing materials should be at least 20 mm in order to avoid condensation on the surface of the sealing.
- Be sure to insulate the liquid and gas-side field piping.

Any exposed piping may cause condensation or burns if touched.

(The highest temperature that the gas-side piping can reach is around  $120^{\circ}\text{C}$ , so be sure to use insulating material which is very resistant.)

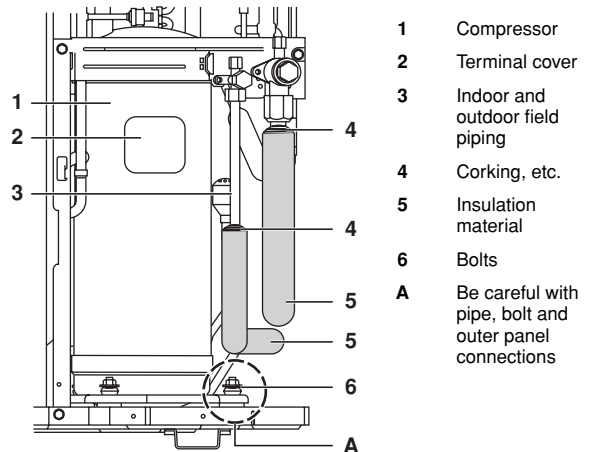

- |   |  |
|---|--|
| 1 | Compressor   |
| 2 | Terminal cover   |
| 3 | Indoor and outdoor field piping                        |
| 4 | Corking, etc.  |
| 5 | Insulation material                                    |
| 6 | Bolts  |
| A | Be careful with pipe, bolt and outer panel connections |

## Cautions for necessity of a trap

Since there is fear of the oil held inside the riser piping flowing back into the compressor when stopped and causing liquid compression phenomenon, or cases of deterioration of oil return, it will be necessary to provide a trap at an appropriate place in the riser gas piping.

### ■ Trap installation spacing. (See figure 4)

- A Outdoor unit
- B Indoor unit
- C Gas piping
- D Liquid piping
- E Oiltrap
- H Install trap at each difference in height of 10 m.

- A trap is not necessary when the outdoor unit is installed in a higher position than the indoor unit.

## LEAK TEST AND VACUUM DRYING

When all piping work is complete and the outdoor unit is connected to the indoor unit, it is necessary to (a) check for any leakages in the refrigerant piping and (b) to perform vacuum drying to remove all moisture in the refrigerant piping.

If there is a possibility of moisture being present in the refrigerant piping (for example, rainwater may have entered the piping), first carry out the vacuum drying procedure below until all moisture has been removed.

### General guidelines

- All piping inside the unit has been factory tested for leaks.
- Use a 2-stage vacuum pump with a non-return valve which can evacuate to a gauge pressure of  $-100.7$  kPa (5 Torr absolute,  $-755$  mm Hg).
- Connect the vacuum pump to **both** the service port of the gas stop valve and the liquid stop valve to increase efficiency.



- Do not purge the air with refrigerants. Use a vacuum pump to evacuate the installation. No additional refrigerant is provided for air purging.
- Make sure that the gas stop valve and liquid stop valve are firmly closed before performing the leak test or vacuum drying.

### Setup

(See figure 5)

- 1 Pressure gauge
- 2 Nitrogen
- 3 Refrigerant
- 4 Weighing machine
- 5 Vacuum pump
- 6 Stop valve

## Leak test

The leak test must satisfy specification EN 378-2.

### 1 Vacuum leak test

- 1.1 Evacuate the system from the liquid and gas piping to  $-100.7$  kPa (5 Torr).
- 1.2 Once reached, turn off the vacuum pump and check that the pressure does not rise for at least 1 minute.
- 1.3 Should the pressure rise, the system may either contain moisture (see vacuum drying below) or have leaks.

### 2 Pressure leak test

- 2.1 Break the vacuum by pressurizing with nitrogen gas to a minimum gauge pressure of 0.2 MPa (2 bar). Never set the gauge pressure higher than the maximum operation pressure of the unit, i.e. 4.0 MPa (40 bar).
- 2.2 Test for leaks by applying a bubble test solution to all piping connections.



Make sure to use a recommended bubble test solution from your wholesaler.

Do not use soap water, which may cause cracking of flare nuts (soap water may contain salt, which absorbs moisture that will freeze when the piping gets cold), and/or lead to corrosion of flared joints (soap water may contain ammonia which causes a corrosive effect between the brass flare nut and the copper flare).

- 2.3 Discharge all nitrogen gas.

### Vacuum drying

To remove all moisture from the system, proceed as follows:

1. Evacuate the system for at least 2 hours to a target vacuum of  $-100.7$  kPa.
2. Check that, with the vacuum pump turned off, the target vacuum is maintained for at least 1 hour.
3. Should you fail to reach the target vacuum within 2 hours or maintain the vacuum for 1 hour, the system may contain too much moisture.
4. In that case, break the vacuum by pressurizing with nitrogen gas to a gauge pressure of 0.05 MPa (0.5 bar) and repeat steps 1 to 3 until all moisture has been removed.
5. The stop valves can now be opened, and/or additional refrigerant can be charged (see "Charging refrigerant" on page 10).



After opening the stop valve, it is possible that the pressure in the refrigerant piping does not rise. This might be caused by e.g. the closed state of the expansion valve in the outdoor unit circuit, but does not present any problem for correct operation of the unit.

# CHARGING REFRIGERANT

## Important information regarding the refrigerant used

This product contains fluorinated greenhouse gases covered by the Kyoto Protocol. Do not vent gases into the atmosphere.

Refrigerant type: R410A  
GWP<sup>(1)</sup> value: 1975

<sup>(1)</sup> GWP = global warming potential

Please fill in with indelible ink,

- ① the factory refrigerant charge of the product,
- ② the additional refrigerant amount charged in the field and
- ①+② the total refrigerant charge

on the fluorinated greenhouse gases label supplied with the product.

The filled out label must be adhered on the inside of the product and in the proximity of the product charging port (e.g. on the inside of the service cover).

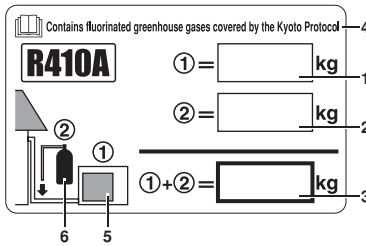

1 Factory refrigerant charge of the product: see unit name plate

2 Additional refrigerant amount charged in the field

3 Total refrigerant charge

4 Contains fluorinated greenhouse gases covered by the Kyoto Protocol

5 Outdoor unit

6 Refrigerant cylinder and manifold for charging

### NOTE



National implementation of EU regulation on certain fluorinated greenhouse gases may require to provide the appropriate official national language on the unit. Therefore, an additional multilingual fluorinated greenhouse gases label is supplied with the unit.

Sticking instructions are illustrated on the backside of that label.

**To avoid compressor breakdown. Do not charge the refrigerant more than the specified amount.**

- This outdoor unit is factory charged with refrigerant and depending on pipe sizes and pipe lengths some systems require additional charging of refrigerant. See "Calculating the additional refrigerant charge" on page 11.
- In case re-charge is required, refer to "Complete recharging" on page 11.

## Precautions and general guidelines



- When servicing the unit requires the refrigerant system to be opened, treatment and evacuation of refrigerant must be done in accordance with relevant local and national legislation.
- Refrigerant can not be charged until field wiring has been completed.
- Refrigerant may only be charged after performing the leak test and vacuum drying (see "Leak test and vacuum drying" on page 9).
- When charging a system, care shall be taken that its maximum permissible charge is never exceeded, in view of the danger of liquid hammer.
- Charging with an unsuitable substance may cause explosions and accidents, so always ensure that the appropriate refrigerant (R410A) is charged.
- Refrigerant cylinders shall be opened slowly.
- Always use protective gloves and protect your eyes when charging refrigerant.



### DANGER

When the power is on, please close the front panel when leaving the unit unattended.

- This unit requires additional charging of refrigerant according to the length of refrigerant piping connected at the site.
- Make sure to charge the refrigerant in liquid state to the liquid pipe. Since R410A is a mixed refrigerant, its composition changes if charged in its gaseous state and normal system operation would then no longer be assured.
- Before charging, check whether the refrigerant cylinder has a syphon attached or not and position the cylinder accordingly.

**Filling using a cylinder with a siphon attached**  
Charge the liquid refrigerant with the cylinder in upright position.

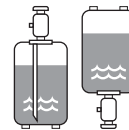

**Filling using a cylinder without a siphon attached**  
Charge the liquid refrigerant with the cylinder in up-side-down position.

## Calculating the additional refrigerant charge

 Piping length is the one way length of gas or liquid piping whichever is the longest.

### For V3 models

It is not necessary to charge additionally if the piping length is under 30 m.

However, if the piping length is under 5 m, a complete recharging of the unit is required. Refer to "Complete recharging" on page 11.

If the piping length is over 30 m please determine the additional amount of refrigerant to be charged using the table below.

**Table 1:** Additional charging of refrigerant <unit: kg>

Refrigerant piping length					
3~5 m	5~30 m	30~40 m	40~50 m	50~60 m	60~75 m
(a)	(b)	0.5	1.0	1.5	2.0

(a) Recharge required, refer to "Complete recharging" on page 11  
 (b) Additional charge not required

### For W1 models

It is not necessary to charge additionally if the piping length is under 10 m.

If the piping length is over 10 m please determine the additional amount of refrigerant to be charged using the table below.

**Table 2:** Additional charging of refrigerant <unit: kg>

Refrigerant piping length						
3~10 m	10~20 m	20~30 m	30~40 m	40~50 m	50~60 m	60~75 m
(a)	0.5	1	1.5	2	2.5	3.0

(a) Additional charge not required

## Complete recharging

 Before recharging, make sure to execute vacuum drying of the internal piping of the unit as well. To do so, use the internal service port of the unit. Do NOT use the service ports located on the stop valve (see "Stop valve operation" on page 7), since vacuum drying can not be performed properly from these ports.

Outdoor units have 1 port on the piping. It is between the heat exchanger and the 4-way valve.

In case complete recharging is required (after a leak, etc.), refer to the table below to determine the necessary amount of refrigerant.

**Table 3:** Total charging amount <unit: kg>

Refrigerant piping length							
	3~10 m	10~20 m	20~30 m	30~40 m	40~50 m	50~60 m	60~75 m
V3	2.7	3.2	3.7	4.2	4.7	5.2	5.7
W1	2.95	3.45	3.95	4.45	4.95	5.45	5.95

## PUMP DOWN OPERATION

This unit is equipped with an automatic pump down operation which will collect all refrigerant from the field piping and indoor unit in the outdoor unit. To protect the environment, make sure to perform the following pump down operation when relocating or disposing of the unit.

**NOTE**  For more details, refer to the applicable service manual.



### WARNING

The outdoor unit is equipped with a low pressure switch or a low pressure sensor to protect the compressor by switching it off. Never short-circuit the low pressure switch during pump down operation!

1. Turn on the main power supply switch.
2. Make sure the liquid stop valve and the gas stop valve are open (see "Stop valve operation" on page 7).
3. Press the pump down button (BS4) on the PCB of the outdoor unit for at least 8 seconds.
4. The compressor and outdoor unit fan will start operating automatically.
5. Once operation stops (after 3 to 5 minutes), close the liquid stop valve and the gas stop valve.
6. The pump down operation is now finished. The remote controller may display "U4" and the indoor pump may continue operating for about 30 seconds. This is not a malfunction. Even when the ON button on the remote controller is pressed, the unit will not start to operate. To restart operation of the unit turn off the main power supply switch and turn it on again.
7. Turn off the main power supply switch.



### WARNING

Make sure to re-open both stop valves before restarting operation of the unit.

## ELECTRICAL WIRING WORK



- All wiring must be performed by an authorized electrician.
- All components procured on the site and all electric construction shall comply with the applicable local and national regulations.



### DANGER

High voltage

To avoid electrical shock, make sure to disconnect the power supply 1 minute or more before servicing the electrical parts. Even after 1 minute, always measure the voltage at the terminals of main circuit capacitors or electrical parts and, before touching, make sure that those voltages are 50 V DC or less.



### To persons in charge of electrical wiring work:

Do not operate the unit until the refrigerant piping is complete. (Running it before the piping is ready will break the compressor.)

## Precautions on electrical wiring work



### DANGER

Before obtaining access to terminal devices, all supply circuits must be interrupted.

- Use only copper wires.
- A main switch or other means for disconnection, having a contact separation in all poles, must be incorporated in the fixed wiring in accordance with relevant local and national legislation. Do not turn on the main switch until all the wiring is completed.
- For W1
  - Make sure to connect power supply cables in normal phase. If connected in reverse phase, the remote controller of the indoor unit indicates "L!" and the equipment cannot operate. Change any two of the three power supply cables (L1, L2, L3) to correct phase.
- Never squeeze bundled cables into a unit.
- Fix cables so that cables do not make contact with the pipes (especially on high pressure side).
- Secure the electrical wiring with cable ties as shown in the figure below so that it does not come in contact with the piping, particularly on the high-pressure side. Make sure no external pressure is applied to the terminal connectors.



### DANGER

Be sure to install an earth leakage circuit breaker in accordance with relevant local and national regulations. Failure to do so may cause electrical shock.

- When installing the earth leakage circuit breaker make sure that it is compatible with the inverter (resistant to high frequency electrical noise) to avoid unnecessary opening of the earth leakage circuit breaker.
- As this unit is equipped with an inverter, installing a phase advancing capacitor not only will deteriorate power factor improvement effect, but also may cause capacitor abnormal heating accident due to high-frequency waves. Therefore, never install a phase advancing capacitor.



### CAUTION

Be sure to install the required fuses.

Secure the wiring in the order shown below.

- 1 Secure the earth wire to the stop valve attachment plate so that it does not slide.
- 2 Secure the earth wire to the stop valve attachment plate one more time along with the electric wiring and the inter-unit wiring.
- Lay the electrical wiring so that the front cover does not rise up when doing wiring work and attach the front cover securely.

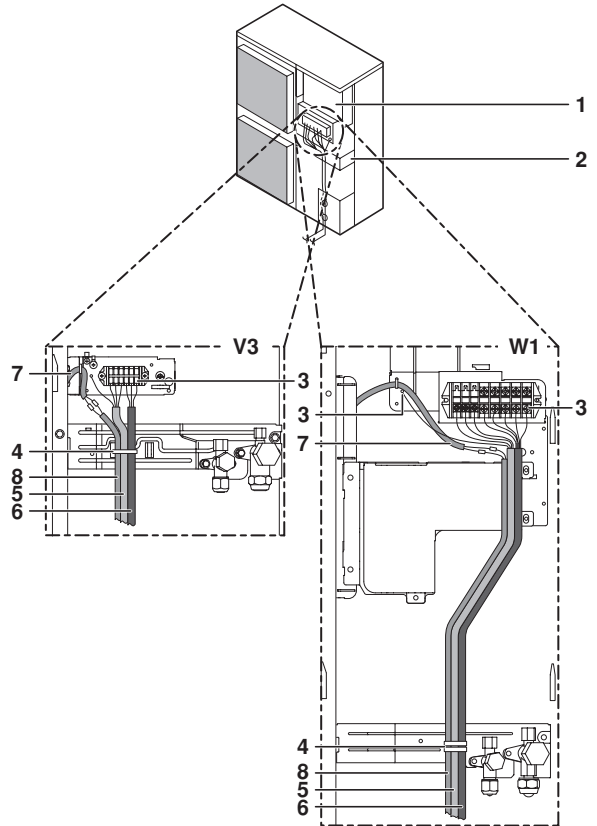

- 1 Switch box
- 2 Stop valve mounting plate
- 3 Earth
- 4 Cable tie
- 5 Wiring between units
- 6 Power supply and earth wiring
- Only if bottom plate heater applicable (ERLQ or optional)
- 7 Bottom plate heater cable
- 8 Power supply of bottom plate heater (from indoor unit)

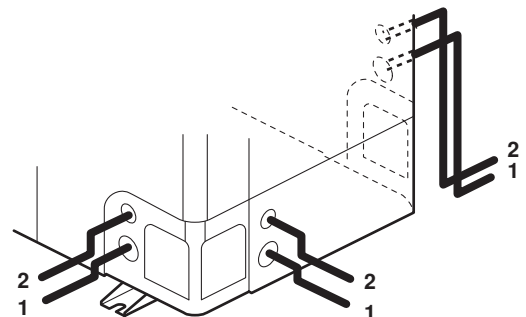

- 1 Power supply, earth wiring, and if applicable: bottom plate heater wire
- 2 Wiring between unit

- When cables are routed from the unit, a protection sleeve for the conduits (PG-insertions) can be inserted at the knock-out hole. (See figure 3)

- 1 Wire
- 2 Bush
- 3 Nut
- 4 Frame
- 5 Hose
- A Inside
- B Outside

When you do not use a wire conduit, be sure to protect the wires with vinyl tubes to prevent the edge of the knock-out hole from cutting the wires.

- Follow the electric wiring diagram for electrical wiring works.
- Form the wires and fix the cover firmly so that the cover may be fit in properly.

### Precautions on wiring of power supply and inter-unit wiring

- Use a round crimp-style terminal for connection to the power supply terminal board. In case it cannot be used due to unavoidable reasons, be sure to observe the following instruction.

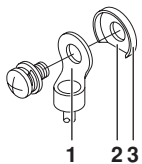

- 1 Round pressure terminal
- 2 Cut out section
- 3 Cup washer

- Do not connect wires of different gauge to the same power supply terminal. (Looseness in the connection may cause overheating.)
- When connecting wires of the same gauge, connect them according to the below figure.



- Use the correct screwdriver to tighten the terminal screws. Small screwdrivers can damage the screw head and prevent appropriate tightening.
- Over-tightening the terminal screws can damage the screws.
- See the table below for tightening torques for the terminal screws.

Tightening torque (N·m)	
M4 (X1M)	1.2~1.8
M5 (X1M)	2.0~3.0
M5 (EARTH)	3.0~4.0

- Refer to the installation manual attached to the indoor unit for wiring of indoor unit, etc.
- Attach an earth leakage circuit breaker and fuse to the power supply line. (See figure 6)

- 1 Earth leakage circuit breaker
- 2 Fuse
- 3 Remote controller

- In wiring, make certain that prescribed wires are used, carry out complete connections, and fix the wires so that outside forces are not applied to the terminals.

### Specifications of standard wiring components

	ERHQ_V3	ERLQ_V3	ERHQ_W1	ERLQ_W1
Phase and frequency	1N~ 50 Hz		3N~ 50 Hz	
Voltage	220~240 V		380~415 V	
Recommended field fuse	32 A		20 A	
Minimum circuit amps <sup>(a)</sup>	28.2 A	28.7 A	13.5 A	14 A
Wire type of wiring between the units	Minimum cable section of 2.5 mm <sup>2</sup> and applicable for 230 V			

(a) Stated values are maximum values (see electrical data of combination with indoor unit for exact values).

**NOTE** Select all cables and wire sizes in accordance with relevant local and national regulations.

**!** After finishing the electrical work, confirm that each electric part and terminal inside the electric part box is connected securely.

For V3 models: Equipment complying with EN/IEC 61000-3-12<sup>(1)</sup>

The wiring diagram can be found on the inside of the front plate of the unit.

(1) European/International Technical Standard setting the limits for harmonic currents produced by equipment connected to public low-voltage systems with input current >16 A and ≤75 A per phase.



## TEST OPERATION



### DANGER

Never leave the unit unattended during installation or servicing. When the service panel is removed live parts can be easily touched by accident..

### NOTE



Note that during the first running period of the unit, required power input may be higher than stated on the nameplate of the unit. This phenomenon originates from the compressor that needs elapse of a 50 hours run in period before reaching smooth operation and stable power consumption.

## Pre-run checks

Items to check	
Electrical wiring Inter-unit wiring Earth wire	<ul style="list-style-type: none"><li>■ Is the wiring as mentioned on the wiring diagram? Make sure no wiring has been forgotten and that there are no missing phases or reverse phases.</li><li>■ Is the unit properly earthed?</li><li>■ Is the wiring between units connected in series correct?</li><li>■ Are any of the wiring attachment screws loose?</li><li>■ Is the insulation resistance at least 1 MΩ?<ul style="list-style-type: none"><li>- Use a 500 V mega-tester when measuring insulation.</li><li>- Do not use a mega-tester for low-voltage circuits.</li></ul></li></ul>
Refrigerant piping	<ul style="list-style-type: none"><li>■ Is the size of the piping appropriate?</li><li>■ Is the insulation material for the piping attached securely? Are both the liquid and gas pipes insulated?</li><li>■ Are the stop valves for both the liquid side and the gas side open?</li></ul>
Extra refrigerant	<ul style="list-style-type: none"><li>■ Did you write down the extra refrigerant and the refrigerant piping length?</li></ul>

- Be sure to perform a test run.
- Be sure to fully open the liquid-side and gas-side stop valves. If you operate the unit with stop valves closed, the compressor will break down.
- Be sure to execute the first test run of the installation in cooling mode operation.
- Never leave the unit unattended with an open front panel during test run.
- To protect the compressor, make sure to turn on the power supply 6 hours before starting operation.
- During tests never pressurize the applications with a pressure higher than the maximum allowable pressure (indicated on the name plate of the unit).

## Test run

Carry out the test run in accordance with the indoor installation manual to ensure that all functions and parts are working properly.

## Failure diagnosis at the moment of first installation

- In case nothing is displayed on the remote controller (the current set temperature does not display), check for any of the following abnormalities before you can diagnose possible malfunction codes.
  - Disconnection or wiring error (between power supply and outdoor unit, between outdoor unit and indoor units, between indoor unit and remote controller).
  - The fuse on the outdoor unit PCB may have run out.
- If the remote controller shows "E3", "E4" or "LB" as an error code, there is a possibility that either the stop valves are closed, or that air inlet or air outlet are blocked.
- If the error code "L2" is displayed on the remote controller, check for voltage imbalance.
- If the error code "L4" is displayed on the remote controller, it is possible that air inlet or air outlet are blocked.
- The reversed phase protection detector of this product only works during the initialisation stage after a power reset. The reversed phase protection detector is designed to stop the product in case of an abnormality when the product is started up.
  - When the reversed phase protection circuit forced the unit to stop, check if all phases are existing. If this is the case, shut off the power supply to the unit and replace two of three phases. Turn on power again and start the unit.
  - Reversed phase detection is not performed while the product is operating.
  - In case of possible reversal of phases after a momentary black out of power and the power goes on and off while the product is operating, install a reversed phase protection circuit on site. Such situation is not unimaginable when using generators. Running the product in reversed phase can break the compressor and other parts.
- For a missing phase in case of W1 units, "E7" or "L2" will be displayed on the remote controller of the indoor unit. Operation will be impossible with either one of these phenomena. If this happens, turn off the power, re-check the wiring and switch the position of two of the three electrical wires.

## MAINTENANCE AND SERVICING

### Service precautions



**WARNING: ELECTRIC SHOCK**

#### Caution when performing service to inverter equipment



**DANGER**

- Do not touch live parts for 10 minutes after the power supply is turned off because of high voltage risk.
- Make sure that the power supply is turned off before performing the maintenance work. The heater of the compressor may operate even in stop mode.

- Please note that some sections of the electric component box are extremely hot.
- In order to prevent damage to the PCB, first eliminate static electricity by touching a metal part (e.g. stop valve) with your hand. Then pull out the connector.
- After measuring the residual voltage, pull out the outdoor fan connector.
- Make sure you do not touch a conductive section.
- The outdoor fan may rotate due to strong backblow wind, causing the capacitor to charge. This may result in an electric shock.

After maintenance, make sure the outdoor fan connector is connected again. Otherwise, the unit may break down.



**Play it safe!**

Touch a metal part by hand (such as the stop valve) in order to eliminate static electricity and to protect the PCB before performing service.

### Service mode operation

Refer to the service manual to carry out any service mode operation.

## DISPOSAL REQUIREMENTS

Dismantling of the unit, treatment of the refrigerant, of oil and of other parts must be done in accordance with relevant local and national legislation.

## UNIT SPECIFICATIONS







### Technical specifications

	V3	W1
Casing material	Painted galvanised steel	Painted galvanised steel
Dimensions h x w x d (mm)	1170 x 900 x 320	1345 x 900 x 320
Weight ERHQ/ERLQ (kg)	103/105	108/110
Operation range		
• cooling (min./max.) (°C)	10/46	10/46
• heating (min./max.) (°C)	-20/35	-20/35
• domestic hot water (min./max.) (°C)	-20/35	-20/35
Refrigerant oil	Daphne FVC68D	Daphne FVC68D
Piping connection		
• liquid (mm)	9.52	9.52
• gas (mm)	15.9	15.9

### Electrical specifications

	V3	W1
Phase	1~	3N~
Frequency (Hz)	50	50
Voltage range		
• minimum (V)	207	360
• maximum (V)	253	440

# WIRING DIAGRAM

	: Wire clamp	L	: Live		
	: Terminal strip	N	: Neutral		
	: Connector				
	: Relay connector	BLK	: Black	ORG	: Orange
	: Field wiring	BLU	: Blue	RED	: Red
	: Protective earth screw	BRN	: Brown	WHT	: White
	: Noiseless earth	GRN	: Green	YLW	: Yellow

- NOTE 1 This wiring diagram only applies to the outdoor unit
- NOTE 4 Refer to the option manual for connecting wiring to X6A/X77A
- NOTE 5 Refer to the wiring diagram sticker (on back of front panel) on how to use BS1~BS4 and DS1 switch
- NOTE 6 Do not operate the unit by short-circuiting protection device S1PH
- NOTE 8 Confirm the method of setting the selector switches (DS1) by service manual. Factory setting of all switches: 'OFF'
- NOTE 9 Option: Option  
Wiring depending on model: Wiring depending on model

A1P~A4P ..... Printed circuit board	R4T ..... Thermistor (heat exchanger)
BS1~BS4 ..... Push button switch	R5T ..... Thermistor (heat exchanger middle)
C1~C4 ..... Capacitor	R6T ..... Thermistor (liquid)
DS1 ..... DIP switch	R7T ..... Thermistor (fin) (for W1 models only)
E1H ..... Bottom plate heater	R10T ..... Thermistor (fin) (for V3 models only)
E1HC ..... Crankcase heater	RC ..... Signal receiver circuit (for V3 models only)
F1U~F9U ..... Fuse	S1NPH ..... Pressure sensor
HAP (A1P) ..... Service monitor (green)	S1PH ..... Pressure switch (high)
HAP (A2P) ..... Service monitor (green) (for W1 models only)	TC ..... Signal transmission circuit (for V3 models only)
H1P~H7P (A1P) ..... Service monitor (orange) (for W1 models only)	V1R ..... Power module (for V3 models only)
H1P~H7P (A2P) ..... Service monitor (orange)	V1R, V2R ..... Power module (for W1 models only)
K1M, K2M ..... Magnetic contactor (for W1 models only)	V2R, V3R ..... Diode module (for V3 models only)
K1R~K4R ..... Magnetic relay	V3R ..... Diode module (for W1 models only)
K10R, K11R ..... Magnetic relay (for V3 models only)	V1T ..... Insulated gate bipolar transistor (for V3 models only)
L1R~L4R ..... Reactor	X1M ..... Terminal strip
M1C ..... Motor (compressor)	X1Y ..... Connector
M1F ..... Motor (fan) (upper)	X6A ..... Connector (option)
M2F ..... Motor (fan) (lower)	X77A ..... Connector
PS ..... Switching power supply	Y1E ..... Expansion valve
Q1DI ..... Earth leakage circuit breaker (field supply)	Y1S ..... Solenoid valve (4 way valve)
R1~R4 ..... Resistor	Y3S ..... Solenoid valve (for W1 models only)
R1T ..... Thermistor (air)	Z1C~Z9C ..... Noise filter
R2T ..... Thermistor (discharge)	Z1F~Z4F ..... Noise filter
R3T ..... Thermistor (suction pipe)	



\*4PW54249-1 000000B\*

Copyright © Daikin

**DAIKIN EUROPE N.V.**

Zandvoordestraat 300, B-8400 Oostende, Belgium

4PW54249-1